



VOGE

Far & Beyond Quality

MOTORCYCLE OPERATION MANUAL

DS625X



Thanks for your coming to VOGÉ

We give our gratefulness and congratulations for your choice of VOGÉ!

You ought to know your motorcycle as well as yourself for safely driving under various road conditions, in this case, please carefully read this book before driving this motorcycle. This book includes not only the information about driving and equipment but also the suggestions you have to strictly follow. This book also has the information about maintenance, using and prevention you need to know, in case any questions you have, the VOGÉ authorized distributors may provide you suggestions and assistance with pleasure. Enjoy every moment of driving is our best wishes.

About this book

This user manual includes important information, issues need pay attention to, warning and danger reminder. Keep this book on your motorcycle especially when lending or selling to others. Illustration in this book may have tiny difference with the actual motorcycle but their theory described are the same. When you don't need the motorcycle anymore, sell with this book together, because it is an inseparable part of the motorcycle. The VOGÉ keeps high safety and quality due to her constant and further research, design and improvement, which may lead to difference between the use manual and actual motorcycle, in this case, the VOGÉ distributors may make correction at all time.

The executed standard of this motorcycle: Q/LX1050-2024

Comprehensive writing code of this user manual: GB/T 19678.1、GB/T 9969、GB/T 40494

The Loncin motor reserves all the right for final explanation.

Important issues need pay attention to

When you saw the warning symbols below, please follow and adopt these safe driving or maintenance procedures.

▲ Danger This symbol indicates the possibility may lead to hurt, death or potential harms.

▲ Warning This symbol indicates the possibility may lead to damage to the motorcycle.

▲ Caution This symbol indicates driving essentials which are more efficient and convenient.

▲ Danger

This motorcycle suits the driver with corresponding certificate only under reasonable and cautious driving. Pay attention to the issues below:

Refit the motorcycle by user himself is not allowed.

Follow the local laws and regulations.

Any refit on device or electrical parts on this motorcycle may influence its noise, emission and performance.

The constant improvement may lead to difference between this book and actual motorcycle, which set the actual motorcycle as standard and subject to technical changes without further notice.

The directory

Motorcycle identification	1
Motorcycle head	2
Left side of motorcycle	3
Right side of motorcycle	4
Lower side of seat.....	5
Information for loading and accessories	6
Issues need pay attention to during driving	7
Ignition switch.....	8
Instrument and indicator light	9
Installation and usage instructions for VOGÉ Global APP	18
Issues need pay attention to about fuel filling-up ..	24
Insufficient oil pressure	25
Too high the coolant temperature	25
Insufficient coolant	26
Emergency light	26
Handle bar assembly switch	27
USB power source interface.....	30
Gearshift pedal.....	31

Side stand.....	31
Adjustment before driving.....	33
Adjustment for front brake lever	34
Adjustment for gearshift pedal	34
The adjustment for rear brake pedal.....	35
Adjustment for throttle grip	36
Adjust the clutch lever	36
Adjustment for front shock absorber.....	37
Adjustment for rear shock absorber.....	38
Light beam adjustment for headlight.....	41
New motorcycle grinding-in	42
Engine grinding-in	42
Tire running-in.....	43
Brake system grinding-in.....	43
Motorcycle driving	44
The engine starting.....	45
Driving on the road.....	46
Use the gearshift device	47
Brake and parking	47
ABS unit	49

The use of ABS system.....	49	Adjust the transmission chain.....	71
TCS traction control system.....	52	Maintain the tire	72
The fuel	53	The fuse.....	74
The fuel evaporation	54	Brake pads.....	76
The Three-way catalyst.....	55	Replace the fuel filter	77
Troubleshooting.....	56	Replace the lighting signals.....	78
The engine starting failed	56	The storage and cleaning up of motorcycle	79
The hard engine starting	56	Refit and accessories.....	81
Weak power of engine.....	56	The motorcycle parameters.....	82
Check and maintenance.....	57	The maintenance plan	84
The maintenance of air filter	60	Electrical schematic diagram.....	86
Maintenance of oil in engine.....	61		
Check the oil level	61		
Replace the oil in engine	63		
Replace the oil element.....	64		
Fill up the engine oil.....	65		
Check and maintain the coolant	66		
Replace the coolant.....	67		
Maintain the brake fluid.....	69		
Maintain the transmission chain.....	70		

Motorcycle identification

Vehicle Identification Number VIN and Motorcycle products plate
Engine type number and Manufacturing number

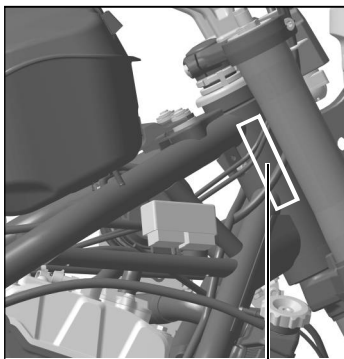

Vehicle Identification
Number (VIN)

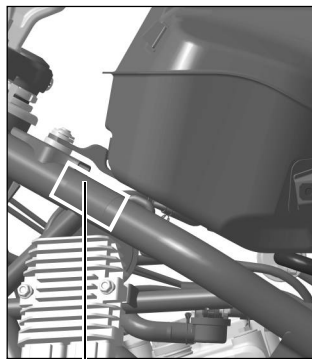

Motorcycle products plate

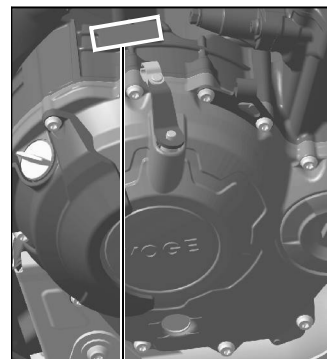

Engine type number and
Manufacturing number

Motorcycle head

- 1.Clutch lever
- 2.Left switch assembly
- 3.Instrument
- 4.Fuel tank cap
- 5.Ignition switch
- 6.Front brake master cylinder
- 7.Right switch assembly
- 8.Front brake lever

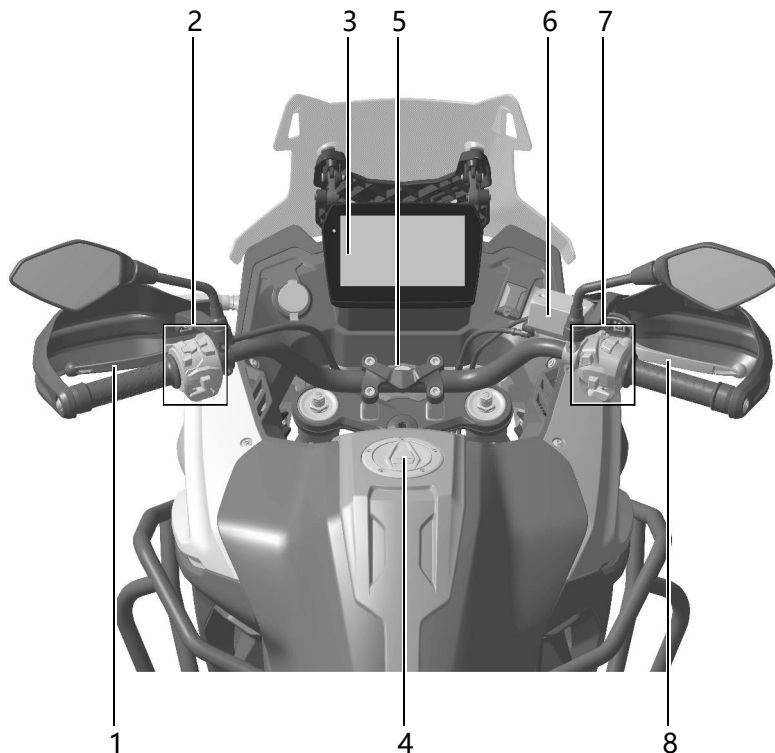

Left side of motorcycle

1. Thermostat
2. Coolant filling-up port
3. Side stand
4. Gearshift arm
5. Engine oil drainage bolt
6. Front brake pump

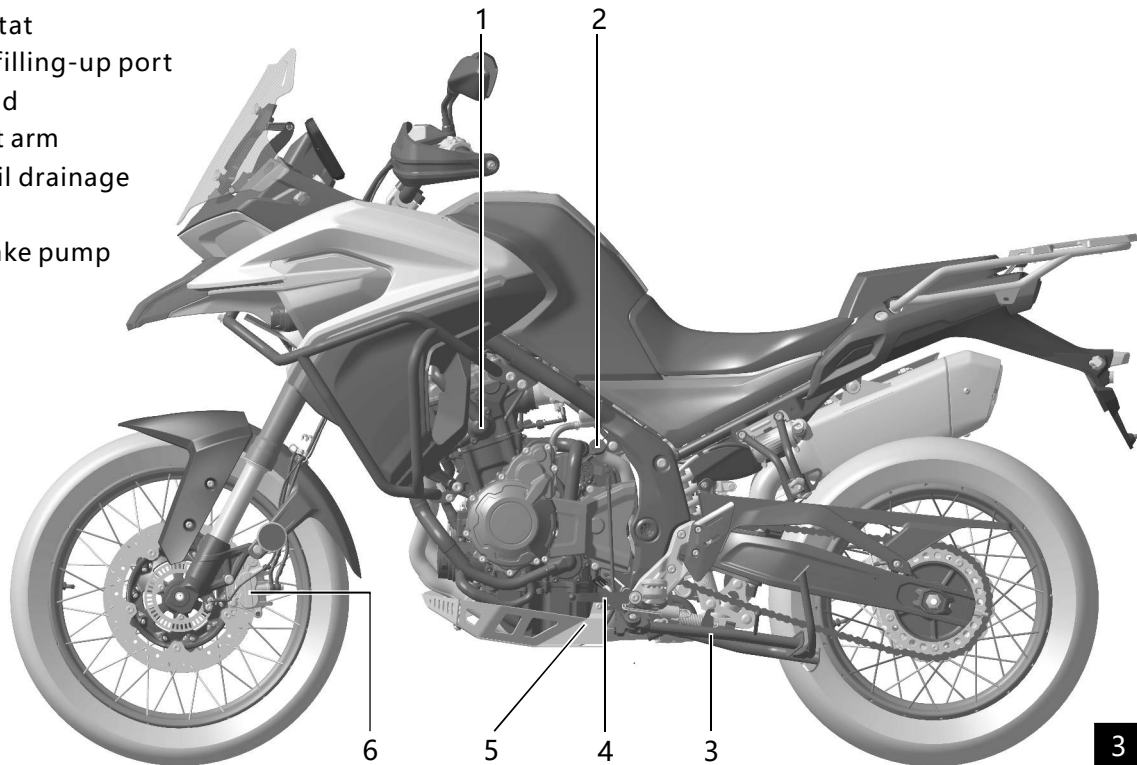

Right side of motorcycle

1. Water temperature sensor
2. Heat radiator water filling-up port
3. Oil element
4. Oil pressure sensor
5. Rear brake oil cup
6. Speed sensor

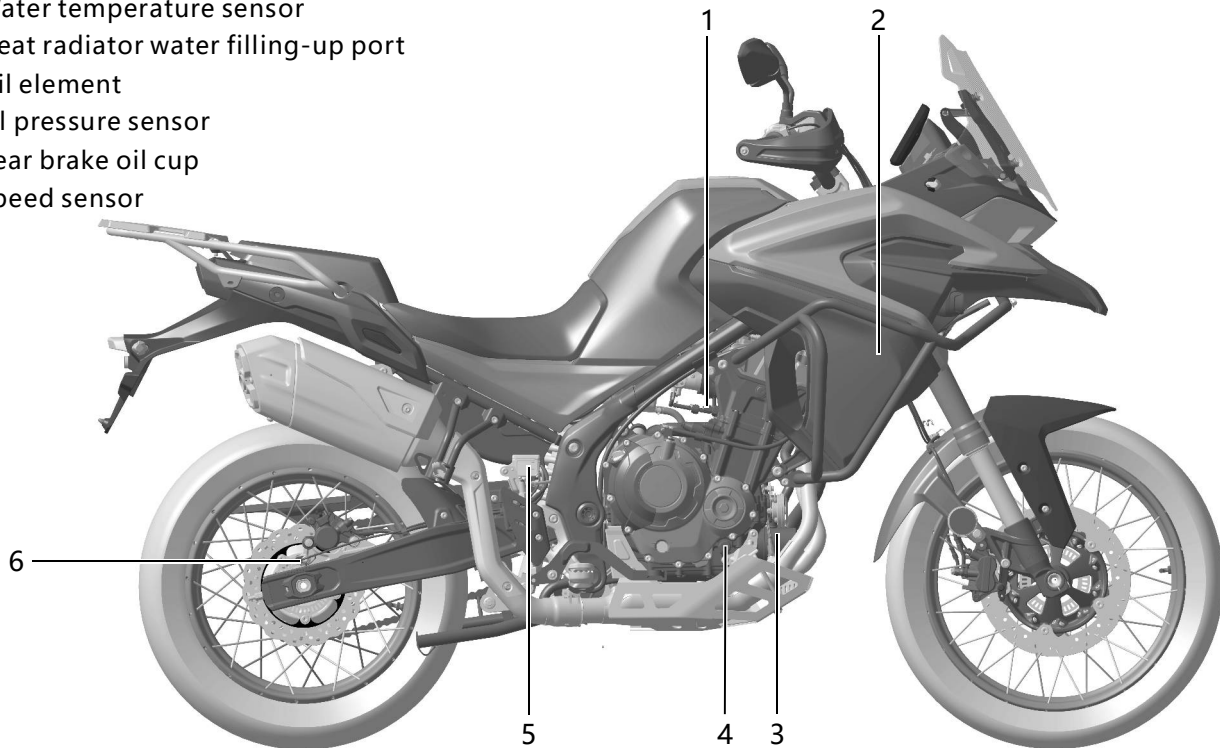

Lower side of seat

- 1.ECU
- 2.Fuse case
- 3.Battery
- 4.Dumping switch
- 5.Air filter
- 6.Starting relay (Under Dumping switch)
- 7.ABS controller (Under battery)
- 8.Relay
- 9.Interface of diagnosis device
- 10 way fuse and control relay diagram (There are 7 branches for motorcycle power supply, which get power for positive pole of battery and with 1 fuse each, who are independent without interference).

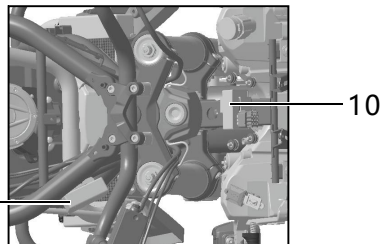
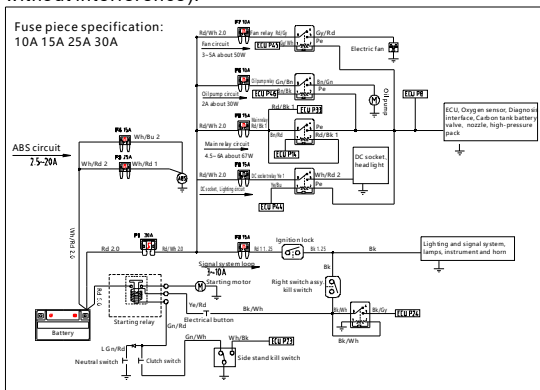
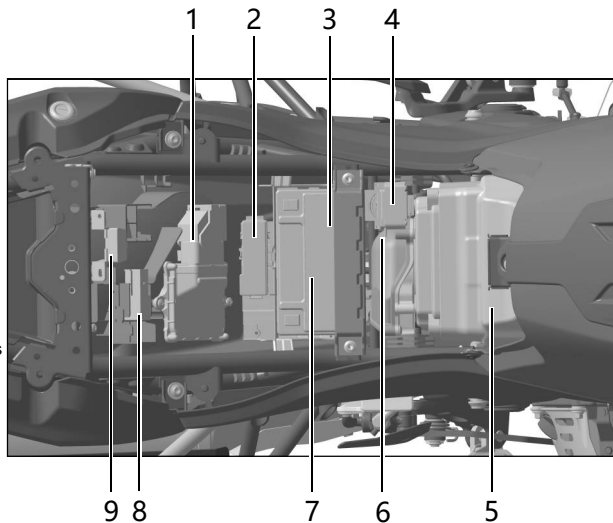

Information for loading and accessories

Danger

Incorrect loading, unsuitable refit or accessories and improper maintenance all may lead to hidden risk for driving; Confirm the motorcycle follow the stipulations above and without overloading before driving.

Please adopt VOGÉ original and authorized parts only. The Non-VOGÉ parts, incorrect accessories or improper loading all may badly influence the motorcycle performance even break laws, please pay attention to your responsibility on safety of yourself and others.

Caution

The components and accessories equipped on our motorcycles are all specially designed and verified, in this case, we strongly suggest you adopt the VOGÉ original and authorized components and accessories.

The changes of curb weight sharply influenced the motorcycle performance, so you must accept our suggested loading or passenger weight and accessories.

Issues need pay attention to during driving

1. Any driver must know well about his motorcycle, unsuitable sitting position, gravity center offset, or sudden moving during driving may influence the operation and control of motorcycle; During driving, the passenger ought to steadily sit on the motorcycle for avoiding impact on driver. Animal passenger on the motorcycle is not allowed;
2. The loading luggage on motorcycle ought to be on low position for avoiding impact on motorcycle gravity center; The weight of luggage shall be evenly distributed on both sides of motorcycle. The extended length behind motorcycle shall not be too long.
3. The luggage shall be firmly fixed on the motorcycle and confirm could not move before driving. In case there is instability felt during driving, check the tightness of luggage, and adjust if necessary.
4. Load the too big or heavy luggage is not allowed. Overloading may surely influence and operation and power performance.
5. Install or load the accessories and luggage may decrease motorcycle performance is not allowed, make sure what you did won't influence any lights system, ground clearance, roll angle, operation performance, tire compression stroke, front fork working travel or other performances relate to driving.
6. Impose weight on handle bar or front fork may influence turning performance and lead to danger during driving.
7. Fairing cover, windshield glass, backrest or other large sized parts may influence stability and driving performance, which increased not only weight but also the raised area decreased power performance. Installation of these parts may lead to danger due to be short of verification during design.
8. Refit to side tricycle, dragging trailer or other vehicle is not allowed, the damage or hurt due to unauthorized refit we take no responsibility.



The Maximum loading: Within 183kg including driver, luggage and accessories.



Ignition switch

The ignition switch of this motorcycle is on the front end of upper connective plate, which is in one body with steering lock.

This motorcycle equipped 2 pieces of keys in which 1 is for spare use need be well kept.

The Ignition lock, steering lock, seat lock, side cover lock and that of fuel tank shared only 1 key.

There are three positions on the ignition switch: “” means the ignition circuit connected which could be started anytime and all the functional circuits are connected. The key is unable to be removed when in this position. “” means the ignition switch circuit cut off which is unable to be started. The key could be removed when in this position.

“” means lock up the steering stem, turn the handle bar to the most left position first and press down the key on position “”, then turn the handle bar anticlockwise to position “”. The key could be removed in this position. The ignition circuit cut off which could not be started

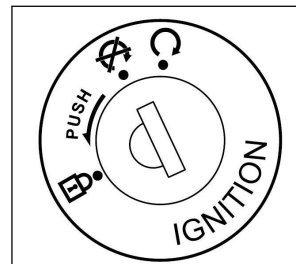

Caution

The motorcycle is parked with the side bracket, for ensuring the parking stability, try everything possible turn the handle bar to the most left position rather than the most right when locking up the handle bar.

Danger

Turn the ignition key to position “” during driving is not allowed or may bring the motorcycle out of control.

Instrument and indicator light

- 1.Photoelectric sensor(position)
- 2.Left turning indicator
- 3.High beam indicator light
- 4.Bluetooth connection
- 5.Side stand switch indicator
6. Indicator light for kill switch
- 7.Oil pressure alarm light
- 8.Engine malfunction alarm
- 9.Coolant thermometer and alarm light
- 10.Engine rotation meter
- 11.Right turning indicator
- 12.Speed indicator
- 13.Basic navigation
- 14.Gear position display
- 15.Fuel meter and low level alarm
- 16.ABS malfunction alarm light
- 17.Maintenance indicator
- 18.Voltage malfunction alarm light
- 19.Total mileage/Mileage subtotal/Call reminder /Bluetooth account (Startup prompt)
- 20.Time
- 21.Voltage in battery/Surrounding temperature/Fuel consumption average
- 22.Pressure in tires and their alarm
- 23.TCS switch indicator
- 24.Display for driving mode

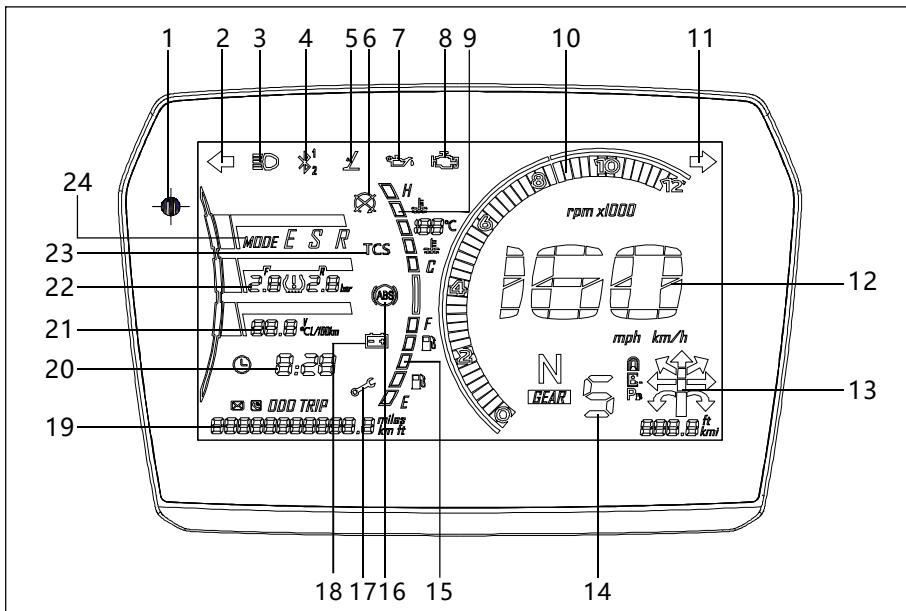

Turn the ignition key to position "Ⓚ" and the instrument starts its self-inspection: The liquid screen is on and starts self-inspection which show the current status of motorcycle. The coolant temperature alarm light "🌊" is on during its self-inspection, then goes off after inspection finished. The EFI malfunction alarm light "🛢️", ABS malfunction alarm light "ABS" and oil pressure alarm light "🛢️" are on.

⚠️ Warning

Wash the instrument by high-pressure water is not allowed. Wipe up the instrument by gasoline or ethanol may lead to crack or color fading.

Left turning signal light "↩️"

When the turning switch on left switch assembly pushed to position "↩️", the indicator light "↩️" is on.

The neutral indicator light "N"

When the engine is on the neutral gear, the indicator light "N" is on.

EFI malfunction alarm light "🛢️"

When there was malfunction in EFI system, the alarm light "🛢️" is on.

When the ignition key turned to position "Ⓚ", the indicator light "🛢️" is on.



The indicator light "🛢️" goes off immediately when the engine started.

⚠️ Warning

In case the light "🛢️" keeps on or flash after engine started, the engine may fail starting or the fuel system may stop if continue the use. In case the light "🛢️" keeps on or flash during driving, stop the motorcycle and contact the VOGÉ distributor immediately.

The ABS malfunction alarm light “”

When the ABS system was in malfunction, whose alarm light “” is on.



When turned the ignition key to position “”, whose alarm light “” is on; The alarm light “” goes off immediately when the engine started.

Danger

In case the alarm light “” is on or flashes after engine started, continue driving may lead to abnormal wheel brake or locking-up, under this case, stop driving.

In case the alarm light “” is permanent on or flashes during driving, stop the motorcycle and contact VOGÉ distributor immediately.

Right turning signal light indicator “”

When pushed the turning switch on right switch assembly to the right position “”, the indicator light “” goes on.

High beam indicator light “”

When pushed the headlight switch on left switch assembly upwards, the indicator light “” goes on.

When pressed the overtaking switch on left switch assembly, the indicator light “” goes on till you release the switch.

The coolant temperature alarm light “”

When the coolant in engine is hot, the alarm light “” goes on.

⚠ Caution

When the coolant temperature alarm light “” is on, which means the engine overheated, under this case, continue the driving may damage the engine.

When the coolant temperature alarm light “” was on, stop the motorcycle and engine immediately till the light goes off. Check the coolant and heat radiator after the motorcycle and engine was complete cooled down.

In case the coolant level is too low, fill it up.

In case the fan of heat radiator doesn't work when the coolant temperature light was on, stop the engine and contact the service station nearby for troubleshooting.

⚠ Caution



In case the alarm light “” of coolant is on, please check if the guardrail of heat radiator blocked by sand or mud, if so, clean it up, or the heat radiating performance may be largely decreased.

In case the coolant is insufficient or the radiator blocked by sand and mud, our suggestion is as below:

- Reduce the loading for decreasing the heat generated by engine.
- In case the traffic jam is met, make the engine in idling while avoiding temperature rise by turning the throttle grip.
- In case the actions above don't work, stop the engine and contact the specialized service station nearby for troubleshooting.

The oil pressure alarm light “”

12 When the oil pressure is lower than the normal, the alarm light “” on.

When the ignition key turned to position "  ", the alarm light "  " on; When the engine started, the alarm light "  " goes off immediately.

Caution

The alarm light "  " for oil pressure shows the abnormal oil pressure rather than the oil level, so periodic inspection for oil level is necessary.

Warning

In case the alarm light "  " of engine oil pressure permanently on after it started or during driving, continue driving may lead to engine damage due to poor lubrication caused by low oil pressure. Under this case, stop the engine and motorcycle to check the oil level.

Indicating light of "TCS"

When the motorcycle got power on, the indicating light of TCS is slowly flashing, when the motorcycle got into normal driving, the indicating light goes off.

Operate the key on switch assy., the TCS could be got off through meter, when it got off, the letters "TCS" of its indicating light will keep on.

Every time when the motorcycle got power on, the default for TCS is on.

When the TCS was on, during driving, in case the rear tire is skidding, the TCS may automatically reduce the torque of engine to decrease tire

skidding. When the TCS is working, the letter "TCS" on its indicating light may fast flash.

Warning

When the TCS is on and during driving, in case the indicating light of TCS is permanently on, which means there is malfunction in TCS, please contact the dealer of VOGÉ immediately.

Negative display instrument

When the meter was on: When the meter was on, it shows you the information mode for setup of last time.

The backlight of meter: The meter adjusts the backlight according to light intensity.

Connection for Bluetooth: When connected the cell phone to meter through Bluetooth, the meter can achieve call reminder (Call number + Person name), Install APP on end of mobile phone to achieve basic navigation.

Tire pressure display: Match the sensor for tire pressure, show you the current pressure in Front/Rear tire. When the pressure is ≤ 1.9 bar or ≥ 2.9 bar, the mark of tire pressure and its corresponding "F" or "R" flashing and alarming.

Rotation speed: The rotation speed of engine. (r/min-rotation speed/minute—The numbers for turning rounds of crankshaft at current minute.)

Gear position of driving: The current gear position of engine. (Not in neutral gear)

Speed: The driving speed of motorcycle. (km/h-kilometers/hour, or mph-miles/hour).

Fuel consumption: Show you the fuel consumption every hundred kilometers. When cut off the power of battery or erase the single mileage, the average fuel consumption at current may clear to 0.

Water temperature: The current temperature of coolant. (Unit: °C Centigrade, with displaying range from -9°C~143°C, when the temperature is ≥ 112 °C, the alarm light for coolant temperature gets on and the indicating bar gets into red)

Displaying area for mode: There are 2 modes for mileage displaying—The ODO show you the total mileage, while the TRIP showing you single mileage, short press the lower key can shift the mode between ODO/TRIP.



Under the mode of ODO, long press the lower key can shift the unit between Imperial/Metric for Speed/Mileage; When got into mode TRIP, long press lower key to erase the record for single mileage. In normal displaying page, short press upper key to shift Voltage/Temperature/Fuel consumption in turn.

Long press the key for confirmation could get into mode of Setup, short press the lower or upper key to setup or match the tire pressure.

Setup of time: When it got into blinking under time mode, short press key confirm, get into blinking of hours place, then short press key up/down to plus or minus data of hour numbers; then short press to get into blinking of minutes place, short press key up/down to plus and minus numbers for minutes; When setup achieved, short press key Return to get back to blinkin of time, then short press key Return to quit mode of setup.

Tire pressure matching: When got into mode of tire pressure matching (The marks for front and rear tire pressure are flashing together), short press lower key to get into front tire flashing (Short press lower key to select front or rear wheel in turn), the short press key for confirmation to get into matching status, start the count down for 60 seconds, keep air discharging for tire, until the success matching for tire pressure, in case the matching was failed in 60 seconds of count down, short press key for confirmation to match once again, until reached success matching. When the matching finished, short press to get back to the flashing status for front and rear tire, finally short press once again to get back to normal page for displaying.

Fuel level: Show you the residual fuel level at the moment; When fuel in tank was about run out, the fuel level may get into cell 1 and whose alarm light got to be yellow, which reminds you a timely fuel filling-up.

Introduction for button functions on negative display instrument:

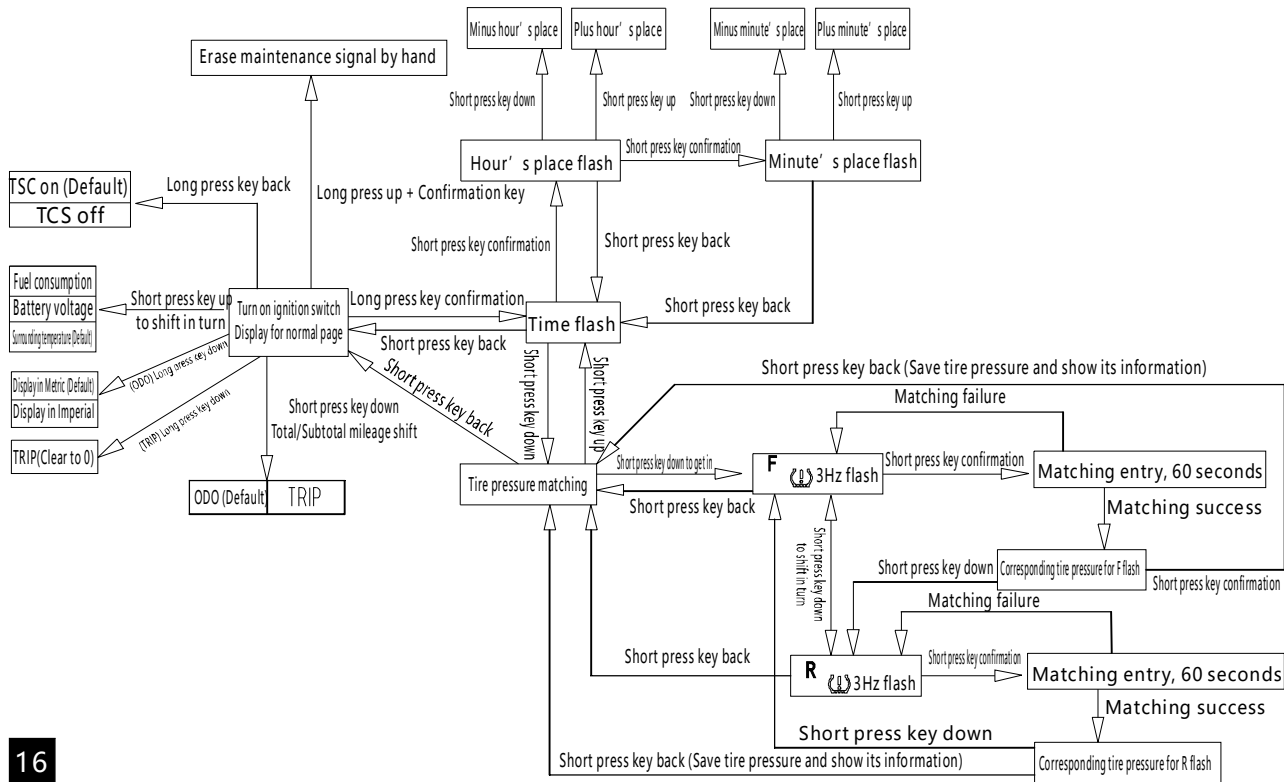

 Caution

The fuel in the tank may fluctuate due to the motorcycle in running which lead to fuel indicator bar flash due to less residual fuel. This kind of situation may repeat for times and then the indicator bar keeps constant on. This is normal situation and don't worry about it. In case the indicator bar flashes during driving, which indicates the residual fuel in the tank is about 2.5L.

 Danger

Operate the instrument during driving is extremely dangerous, the hand left the handle bar may bring the motorcycle out of control.

Installation and usage instructions for VOGE Global APP

1. VOGE Global APP download

1.1 Apple download:

1.1.1 Scan the QR code above by iPhone camera, when successfully

Identified, click links to get to store for downloading.

1.1.2 Enter the iPhone App Store to search for "VOGE Global", and download.

1.2 Android download

1.2.1 Open "Google" of Android cell phone itself, then click the button of camera in Search bar, scan by camera, when successfully recognized, it gets to store for downloading automatically.

1.2.2. Scan the QR code above by any scanning tools for the code, it gets to store for downloading automatically.

1.2.3. Get into Play Store of Android cell phone for searching and downloading.

2. Get mapbox token

2.1 Open the browser and search for mapbox, or click Mapbox.

2.2 Enter account information. (See Figure 1)

2.3 Enter payment information. (See Figure 2)

2.4 After successfully registering the account, locate and click on "create a token" to apply for creating a token.

18 (See Figure 3)

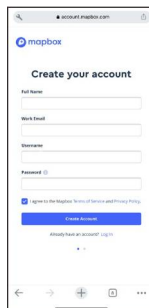

Figure 1

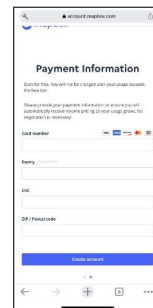

Figure 2

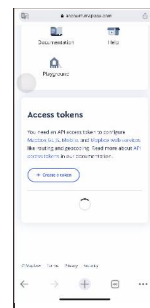
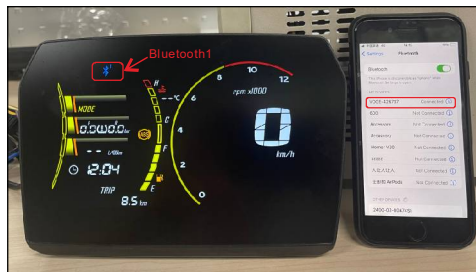
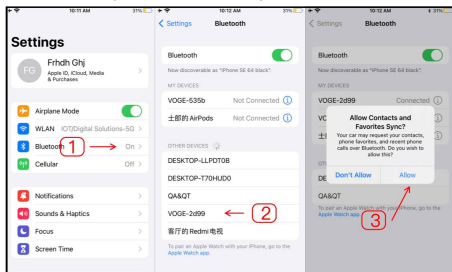

Figure 3

4. Use for basic navigation of Bluetooth

4.1 Get motorcycle power on, open setup for cell phone->Bluetooth, Select Bluetooth name of (VOGE-) as beginning, when successfully connected, allow to visit phonebook, when connected, the instrument will show you the icon of (Bluetooth 1).



4.2 Open VOGÉ Global APP, Click icon of Bluetooth of (BLE-VOGE-) as beginning for connection, when successfully connected, the icon of Bluetooth will turn yellow, the instrument will show you the icon of Bluetooth 2.

4.3 When navigation of VOGÉ Global is working, the instrument will show you corresponding information.

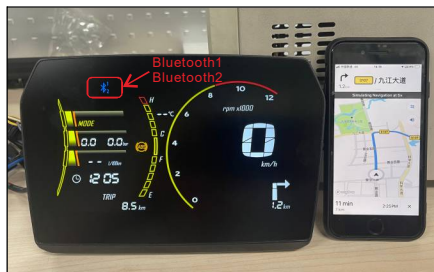
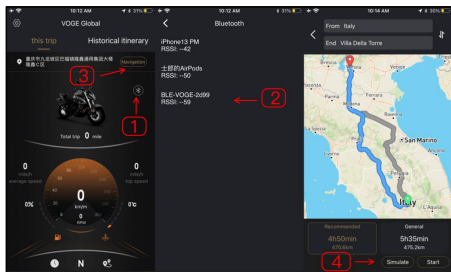

5. The use of driving recorder

5.1 Open the VOGE Global, click [Fuel meter connection] then get into main page of APP, click the icon of camera on the left, get into main page of DVR;

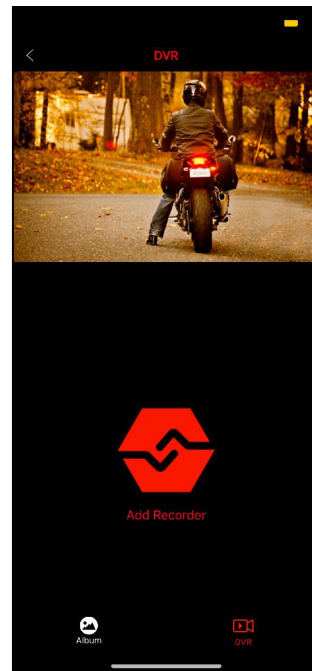
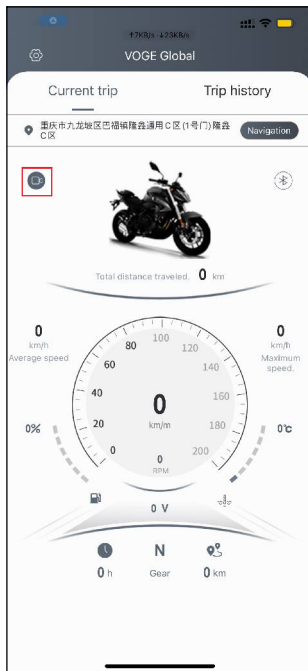
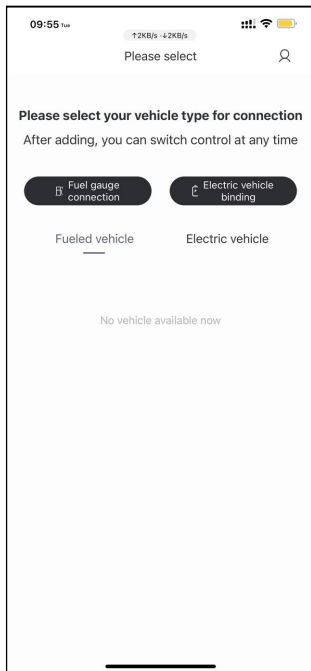

5.2 Click [Add equipment] in main page of DVR, then confirm connection according to reminder, then find out recorder net with beginning of mt in WLAN in setup of mobile phone, then add it in;

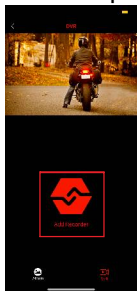

5.3 Click [Photobook] in main page of DVR and get into its page, then click [Selection] to select the video or photo needs be deleted or added in;

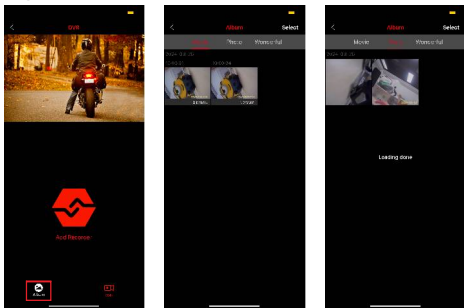

5.4 Click [Recorder] in main page, then shift back to main page of recorder;(See Figure 7)

5.5 When recorder was connected in main page of DVR, click once again the icon for adding equipment to get into page for recording video at real time;(See Figure 8)

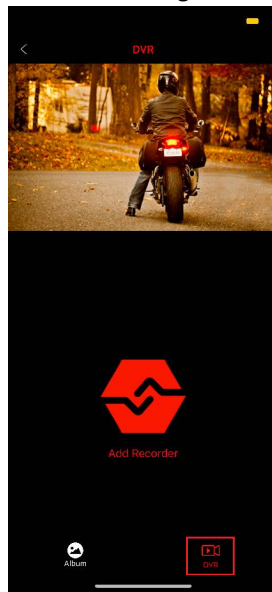

Figure7

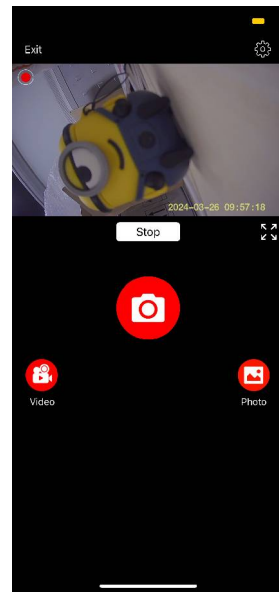
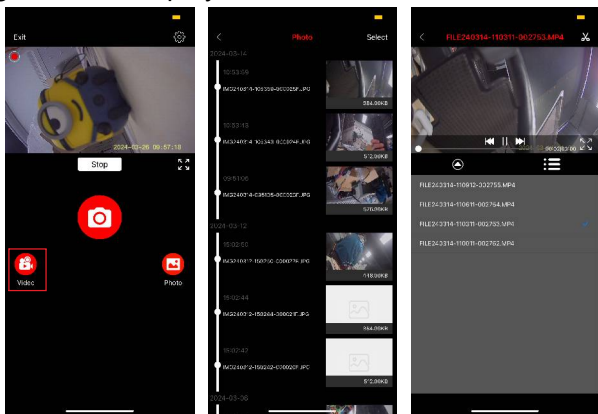

Figure8

5.6 In the page for recording video at real time, click [Recorder Video] to open the list of video, click it to get into video playback;



5.7 In the page for recording video at rear time, click [Recorder photo], it gets into photo list.(See Figure 9)

5.8 In the page for recording video, click the icon in right upper corner to get into setup page for camera parameters, please set up according to your demands.(See Figure 10)

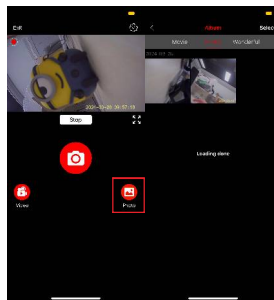

Figure 9

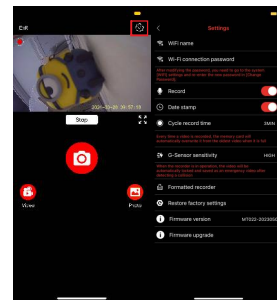

Figure 10

⚠ Caution

- The interface of APP and its function may change with update or upgrade of UI, the final interface and function for using is the same with the latest downloaded version of APP.
- On different models, the limit for authority and function may not be the same.



This alarm light reminds you the fuel filling-up

Caution: The insufficient fuel may lead to engine starting failure, in case it is, continue starting the engine may lead to damage.

Use up the fuel in the tank is not allowed, keep the fuel level above the allowed lowest position.

The allowed lowest fuel level: More than 2L.

Issues need pay attention to about fuel filling-up

Open the fuel tank cap by clockwise turning the ignition key.

After the fuel filled up, return the fuel tank cap to its original position, then powerfully press down the fuel tank cap for locking up, at this moment, the key could be removed. Wash the fuel tank cap by high pressure water injector is not allowed for avoiding water entry.



Spare fuel tank capacity 2.0L

Fuel tank cap

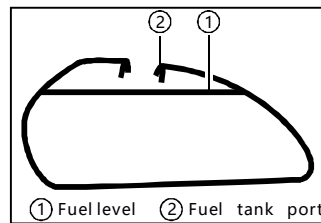

① Fuel level ② Fuel tank port

Fuel tank capacity 17.6L

⚠ Warning

- The fuel may corrode the painting surface which lead to color fading. In case the fuel on the painting surface is found, wipe it up.
 - The fuel may expand when in high temperature, in this case, the complete fuel filling-up may lead to fuel tank distortion or fuel overflow.
- Fuel filling-up higher than the bottom of fuel tank port is not allowed.
Use the unleaded gasoline above 92#.

⚠ Danger

Stop the engine when filling up the fuel, close to smoke, fire or heat source is not allowed.

Insufficient oil pressure

 This alarm light means too low the pressure in lubrication system. Under this case, stop the engine immediately.

Requirement for lubricant performance. The only correction way for confirming the lubricant level is viewing through the oil window.

One of the reasons for the lighting alarm light is the low oil level. Check the oil level in engine, in case it is too low, fill up the oil.

In case the oil level is normal but the alarm light on, which may cause by other reasons. In case continue the driving, the engine may damage. In case the oil level is normal while the alarm light is on, stop driving.

Contact the specialized service station nearby for troubleshooting, of course, the best choice is the authorized distributor.

Too high the coolant temperature

 This alarm light means too high the coolant temperature when the engine is overheated, under this case, continue the driving may damage the engine.

The instructions below need be strictly followed. In case too low the coolant level is found, fill up the coolant in the heat radiator.

Fan malfunction: In case the coolant temperature light is on while the fan doesn't work, contact the service station for troubleshooting, of course, the best choice is the authorized distributor.

Insufficient coolant

Reduce the loading for cooling down the engine if possible. Make the engine at idling when the traffic jammed without turning the throttle grip for avoiding the rise of engine rotation and temperature. In case the coolant temperature frequently goes high, contact the service station for troubleshooting, of course, the best choice is the authorized distributor.



This alarm light indicates the malfunction in EFI system, when it on, keep driving may lead to engine starting failure and the fuel supplying system stopped work.

Stop the engine, turn off the ignition switch, then start again, in case the alarm light goes off, keep driving is allowed; In case the alarm light keeps on, contact the service station for troubleshooting.

Emergency light



The function of emergency light: The four turning signal lights flash all at once.

Handle bar assembly switch

- 1.Clutch lever
- 2.Low/High beam and Overtaking switch
- 3.Up & Down selection
- 4.Key back on meter/TCS switch
- 5.ABS switch
- 6 Confirmation key of ENTER
- 7.Kill switch
- 8.Front brake lever
- 9.Electric starting switch
- 10.Fog light switch
- 11.Emergency button
- 12.Turning signal switch
- 13.Horn switch
- 14.MODE shift

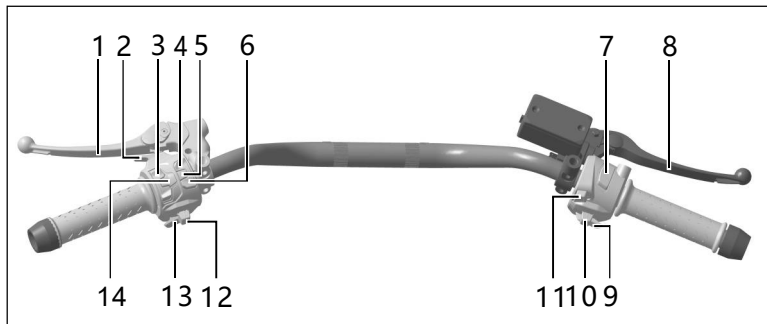

High/Low beam and overtaking switch (When engine is working)

When the high beam/overtaking switch push forward to " ≡D ",the high beam gets on, while the indicating light on instrument " ≡D " also gets on.

When the high beam/overtaking switch move back to " ≡D ",the low beam light gets on, while the indicating light on instrument " ≡D "gets off.

When move back the switch " ≡D ",the high beam is on, while the indicating light on instrument is on" ≡D ",and it recovers when released the switch.

Turning signal light switch

When push the turning signal light switch on left switch assy. to the left " ⇐ ", the turning signal light at left side both front and rear are all on, the indicating light " ⇐ " on instrument is also on.

When the switch on left switch assy. push to right " ⇒ ", the turning signal light at the right side both the front and rear are all on, its indicating light " ⇒ " is also on.

When pressed the turning signal switch on left switch assy. inward, the turning signal lights get off while its indicating light on instrument also gets off.

Emergency light switch " "

When press down button "  " , all the lights such as turning signal light and its indicating light, also the light on instrument gets flashing.

Please let other vehicle know by emergency light in case you met traffic accident or emergency.

Kill switch for electrical starting

With turn kill switch to position "  " , the starting circuit for engine cut off, under this case, engine could not be started.

When engine is working, when kill switch turned to "  " , the engine stops immediately.



Kill switch for electrical starting is the easiest and fastest way to let engine stop.

Front brake lever

Tightly hold the brake lever, the front wheel stopped, meanwhile the rear brake light gets on.

Danger

In case shift kill switch to position "  " during driving, it may lead to rear wheel lock up even accident. Please don't operate kill switch during driving.

Electrical starting button "  " , when pressed down button "  " , the circuit of engine gets connected, then start engine.

Caution

This model equipment the inter-lock between ignition and starting circuit, also with kill switch on side stand, then engine could be started under conditions only as below:

Engine is located at neutral gear position " N " , the ignition and kill switch are at position "  " .

The engine is not in neutral gear position, the ignition and kill switch are at position "  " , pick up side stand and tightly hold clutch lever.

Button " " for horn

When pressing "  ", the horn rings.

Fog lamp switch " "

When pushed the fog lamp switch left to "  " , the fog lamps on both left and right are getting on at same time, then when pushed it right, they got off.

Mode shift button MODE

Short press button "MODE" the driving mode shifts from normal to sporty, then short press, it shift to normal mode (Every time the default is normal mode).

ABS switch

When long pressing ABS switch, get ABS On/Off, when the ignition switch got on once again, the default for ABS is on.

TCS switch

When long pressing the TCS switch, get TCS On/Off, when the ignition switch got on once again, the default for TCS is on.

USB power source interface “”

This instrument integrated the USB power source interface with output specification of 5V2A.

The waterproof rubber cap of USB power source interface is with the mark “”. Open it left and right to normally use the USB power source interface.

Warning

Prepare the charging line by the user himself. After used, well cover the waterproof rubber cap for avoiding dust and water enter the USB power source interface to reduce its working life.

Gearshift pedal

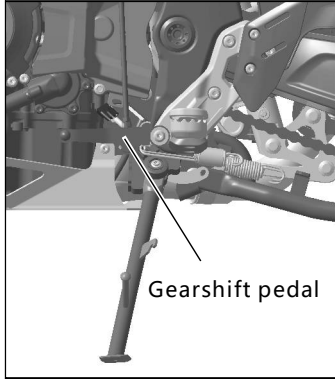

This model equipped gear box of 6, whose gearshift way was shown as below:

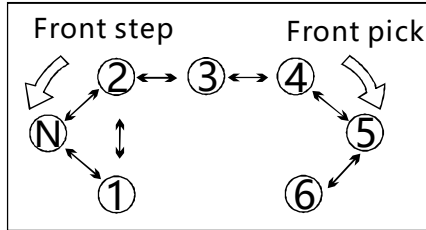

Rear brake pedal: Step down the rear brake pedal, then the rear wheel braked with its indicator light on.

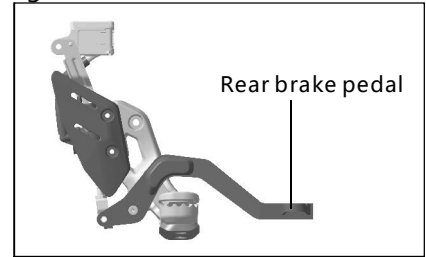

Side stand

The parking system of this model equipped side stand only.

The engine cut for side stand is a design of safety, which is a part in engine starting circuit.

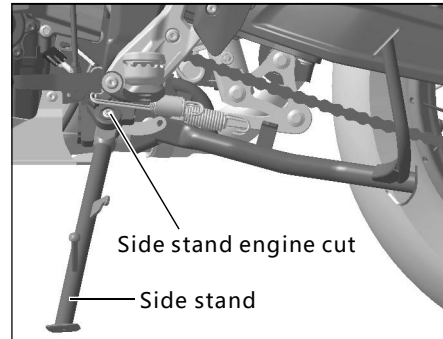

Warning

1. In case on the soft or uneven ground, the motorcycle would be not steadily parked. So please park the motorcycle on solid and smooth ground.
2. In case parking on slope is necessary, put the motorcycle head towards the uphill direction, and lay the engine at its 1st gear for decrease the possibility of side stand turning and motorcycle overturning.
3. The side stand mainly undertakes the weight motorcycle itself, so rely on parked motorcycle is not allowed or the side stand may distort due to it undertake the weight more than its maximum limit.

Caution

1. The engine could be started at the neutral gear when the side stand is working; In case the engine is not at the neutral gear, the engine could not be started.
2. When the side stand picked up, firmly hold the clutch lever, then the engine could be started at any gear position; When the engine was not on the neutral gear, lay down the side stand, then the engine stopped immediately.

Adjustment before driving

Adjust the handle bar

Adjust the handle bar to the comfortable position according to your stature and driving habit.

In case this operation is needed, please contact the VOGÉ authorized distributor.

Loosen the bolt 1

Slightly turn the handle bar to the comfortable position

Lock up the bolt 1

Adjustment for back-view mirror

Adjust the back-view mirror to the correct position according to your stature and driving habit.

The left back-view mirror bar could be directly adjusted by hands.

Loosen the nut 3 by tool from its box on motorcycle for adjusting the right back-view mirror, the lock up the nut 3.

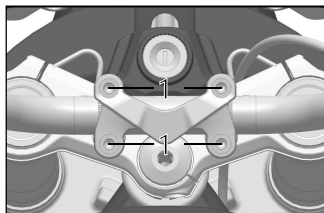

The bolt fastening torque: 25Nm



The fastening torque for nut 3:40Nm

Warning

When the adjustment finished, confirm if there is interference between hands and fuel tank when reached the left and right limit, in case it is, re-adjust to without interference, or it may influence your control on the motorcycle.

Danger

Adjust the back-view mirror during driving is not allowed, or it may decrease your control on the motorcycle.

Adjustment for front brake lever

- The adjusting knob can adjust the gap between brake lever and throttle grip.
- This distance has 5 adjustable positions, with the adjusting way as below:
 - Push the lever forward when adjusting.
 - Turn the adjusting knob to the position you wished.
 - Release the pushing forward lever, and the adjustment finished.

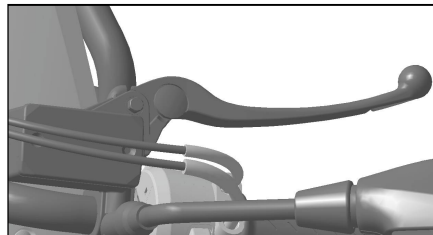

Danger

Adjust the front brake lever during driving is dangerous, the hand left the handle bar may decrease your control on motorcycle.

Adjustment for gearshift pedal

- The road conditions are various during driving, the gearshift pedal can change the driving speed and traction force.
- The rod of gearshift pedal is adjustable to suit your driving habit.
 - Loosen the 2 pieces of hexagonal nut 1 which locking up the connective rod of gearshift.
 - Remove the fixing bolt 3 on gearshift pedal and remove its lower end.
 - Then turn the gearshift connective rod 2 till the pedal adjust to suitable position.
 - Lock up the 2 pieces of hexagonal nut 1.
 - Finally install the gearshift pedal to its holder by screw 3.

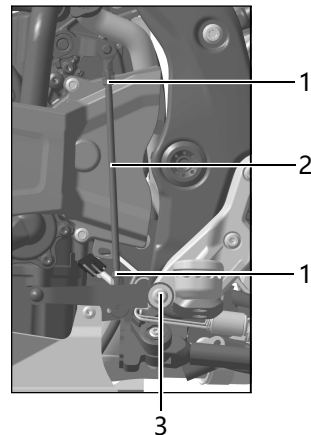

The adjustment for rear brake pedal

- Keep the height of rear brake pedal at a suitable position, if is too high, it may step by mistake in using, which leads to friction between brake pads and plate and makes them damage.
- For ensuring the brake reliability, the free travel of rear brake pedal shall be within 25-35mm, in case it is incorrect, adjust as below:

- Remove the split pin 1.
- Remove the pin axis 2.
- Loosen the nut 3 on adjusting stud.
- Turn clockwise or anticlockwise the connecting part 4 on adjusting stud.
- Turn it clockwise the height of brake pedal may rise, or turn anticlockwise it may fall down.
- Lock up the nut of adjusting rod when the brake pedal adjusted to the suitable height.
- Re-assembly is completely opposite to disassembly.

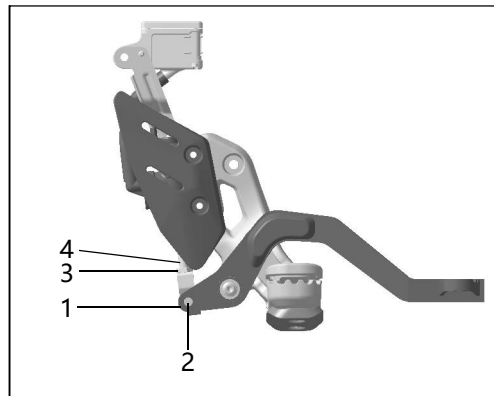

The free travel of rear brake pedal: 25-35mm
The fastening torque for nut of adjusting stud: 18N.m

Danger

- Replace for new split pin when re-assembly.
- Repeatedly press and release the brake pedal for clearly feeling the pressure point.
- In case the pressure point could not be felt, ask and contact the VOGÉ authorized distributor.
- Incorrect adjustment makes the brake pads and plate always under stress which lead to damage.

Adjustment for throttle grip

- The throttle grip is for controlling the engine rotation.
- Turn to driver direction is acceleration, the opposite direction is deceleration.
- Adjust the gap of throttle cable.
 - Remove the rubber jacket 1.
 - Loosen the locking nut 2.
 - Turn the adjustor 3, which adjust the gap of throttle cable within 2-4mm.
 - Lock up the nut 2.
 - Re-assemble the rubber jacket 1.

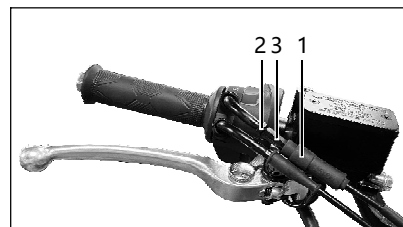

The free clearance of throttle cable: 2-4mm.

Adjust the clutch lever

- Firmly grasp the clutch lever when starting engine, braking or gearshift to let the clutch plates separate for cutting off the engine power.
- The free travel at the end of clutch lever shall be within 5-8mm, in case it is incorrect, adjust as below.
 - Remove the rubber jacket
 - Loosen the locking nut 1
 - Turn the adjustor 2 for ensuring the free travel within 5-8mm.
 - Lock up the nut 1.
 - Re-assemble the rubber jacket.

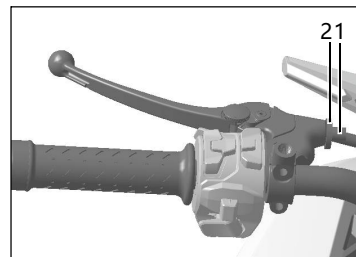

The free clearance at the end of clutch lever: 5-8mm.

⚠ Warning

Too large the free travel of clutch lever may lead to abrasion or malfunction of clutch set and gear box.

⚠ Caution

- When the throttle cable adjusted, make sure the throttle grip return automatically without idling rise.
- When the throttle cable adjusted, turn the handle bar to its left and right limit respectively without idling rise.

Adjustment for front shock absorber

The adjustment for pre-loading and damping is to suit various driver, loading, driving style and road conditions.

- The pre-pressure of spring is adjustable.
- Turn the adjustor 1 anti-clockwise, the pre-loading of spring gets soft.
- Turn the adjustor 1 clockwise, the pre-loading of spring gets hard
- The returning damping for front shock absorber is adjustable.
- Turn the adjustor 2 of left front shock absorber anti-clockwise, the returning damping gets weaker.
- Turn the adjustor 2 of left front shock absorber clockwise, the returning damping gets stronger.
- The compression damping for front shock absorber is adjustable.
- Turn the adjustor 3 of right front shock absorber anti-clockwise, the compression damping gets weaker.
- Turn the adjustor 3 of right front shock absorber clockwise, the compression damping gets stronger.

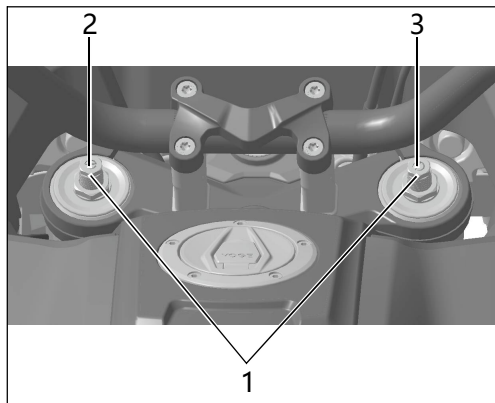

Caution

The operation for adjustor 1 needs open-ended wrench with torque of 14N.m.
Under cold driving condition, please check if the surface of front fork was frozen before driving, in case it is, please wipe it up by clean and dustless tissue.

Adjustment for rear shock absorber

Adjustment for pre-loading and damping of rear shock absorber is to suit various driving, loading, driving style and road conditions.

- The pre-pressure for spring is adjustable.
- Turn the adjusting gear 1 anti-clockwise, the pre-loading of spring gets soft.
- Turn the adjusting gear 1 clockwise, the pre-loading of spring gets hard.

The driving mode with driver only while without loadings (Gear position when it was delivered).

Driver only with 3 cases, turn the adjustor 1 clockwise by 2 rounds.

Driver with passenger and 3 cases, turn the adjustor 1 clockwise by 3 rounds.

We suggest make corresponding adjustment bases upon different road conditions and driving styles.

- Returning damping for rear shock absorber is adjustable.
- Face to the left side of motorcycle, turn the adjustor 2 anticlockwise, the returning damping gets weaker.
- Face to the left side of motorcycle, turn the adjustor 2 clockwise, the returning damping gets stronger.

Driving mode of driver only: Turn the adjustor 2 anti-clockwise to limit, then turn clock wise by 10 positions (Position when it was delivered).

The mode of driver only with 3 cases: Turn the adjustor 2 anti-clockwise to limit, then turn it clockwise **38** by 8 ± 1 positions.

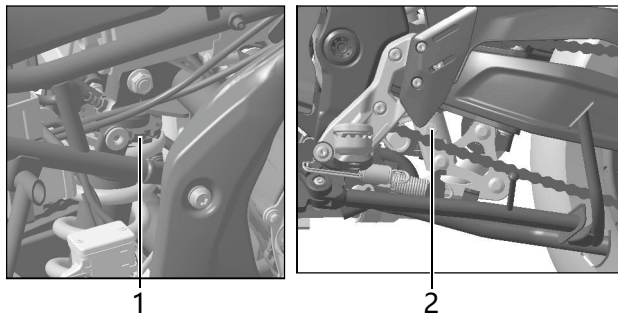

The mode of driver with passenger and 3 cases: Turn the adjustor 2 anti-clockwise to limit, then turn it clockwise by 6 ± 1 positions. We suggest make corresponding adjustment basing up different road conditions and driving styles.

The setup for the 1st gear position:

The method for setup: Align exactly right to damping adjustor, then turn the adjustor clockwise by torque of 0.5N.m until it could not be moved, then turn it back anti-clockwise by torque of 0.5N.m, when you felt the ball falling into groove in place, that is the 1st gear position.

·The compression damping for rear shock absorber is adjustable.

–Face to the left side of motorcycle, turn the adjustor 3 (At position of air bottle) anti-clockwise, the returning damping gets weaker.

–Face to the left side of motorcycle, turn the adjustor 3 (At position of air bottle) clockwise, the returning damping gets stronger.

The mode with driver only without loading: Turn the adjustor 3 anti-clockwise to limit, then turn it clockwise by 10 positions (Position when it was delivered).

The mode with driver only and 3 cases: Turn the adjustor 3 anti-clockwise to limit, the turn it clockwise by 8 positions.

The mode of driver with passenger and 3 cases: Turn the adjustor 3 anti-clockwise to limit, the turn it clockwise by 6 positions.

We suggest make corresponding adjustment basing up different road conditions and driving styles.

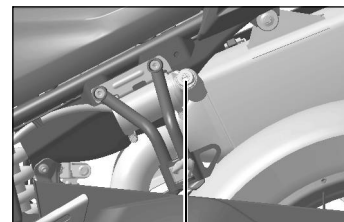

3

 **Caution**

When the adjustors are turned to limit, do not adjust hardly , otherwise the adjustors may damage. When the adjustors are turned to limit, then turn it back into gear positions, which gets working life of adjustor longer.

The adjustment for pre-loading of shock absorber needs tools for it only, the dealer under VOGÉ authorization provides this kind of service.

 **Danger**

Please don't adjust the pre-loading of shock absorber willfully, otherwise the improper adjustment may reduce your control on motorcycle.

In case adjustment is necessary, please contact dealer under VOGÉ authorization to have this work done.

Light beam adjustment for headlight

- The headlight shall keep a reasonable height when the shock absorber under different loadings.
- For ensuring the driving safety at night, adjust the angle of light beam for suiting different loadings.
- The adjusting screws are behind the headlights. Please adjust them in the direction of the cross. See the screwdriver on the right.
- Turn it clockwise for letting the light beam low.
- Turn it anticlockwise to let the light beam high.

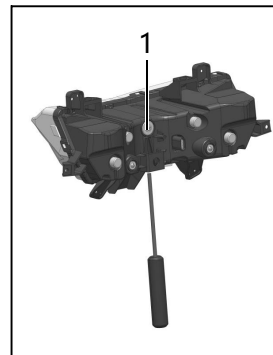

Danger

In case you are not sure the correct height of light beam, contact and ask the VOGÉ authorized distributor for this work.

New motorcycle grinding-in

The grinding-in period largely influence the working life and fuel consumption of the motorcycle, in this case, read the user manual carefully before using (Correctly drive the motorcycle within initial 1000km ensures your motorcycle performance and driving fun).

Engine grinding-in

- It doesn't matter the engine is cold or hot, sufficiently run the engine at idling status to let the oil evenly spread to each lubrication position.
- Within the grinding-in period, the engine rotation speed is not more than 5000r/min within 0-500km, and not more than 7000r/min within 500-1000km.
- Within the grinding-in period, keep the change for gear position without working at one gear position for a long hour.
- Within the grinding-in period, the engine working under low speed and loading for long time may increase abrasion and lead to poor parts matching, so this kind of driving is not allowed.
- Within the grinding-in period, except the emergency, the sudden braking or acceleration shall be avoided.
- The trailer driving is not allowed, reduce the gear in advance before deceleration, which makes engine work under comfortable status.
- Long journey within grinding-in period is not allowed to let engine have enough rest.

Tire running-in

- The new tire is with smooth surface, in case driving in high speed or at bending road is dangerous. For reaching the maximum ground grip, the running-in period is necessary.
- In the initial 200km, driving in low speed at the bending road to get the tire tread angle in place.
- The protrusion on tire tread is dangerous with possibility of accident, which only way for avoiding is running-in.

Brake system grinding-in

In the initial 500km, the new brake plate is at the original status without reaching its optimized friction. Powerfully draw the brake lever for compensating the brake efficiency.

Danger

For the besting running-in, within the initial 200km, the sudden acceleration, turning and braking shall be avoided.

Motorcycle driving

In case the motorcycle is not well checked before driving, the motorcycle may damage and the accident may occur. Please check the items as below:

•Steering system

- Steering stem turn freely without jam
- Steering stem is without runout or flexibility

•Throttle

- Correct throttle cable gap
- Throttle turn freely without jam

•Brake assembly

- Brake lever and pedal operation normal
- Correct brake liquid position in brake oil cup.
- The pressure point is clear in braking operation
- The brake plate and pads without ice or greasy dirt

•Shock absorber

- Press it down can return automatically and smoothly

•Transmission chain

- Without aggressive abrasion or damage.
- Tightness is suitable.

•Tire

- Correct tire pressure
- The depth of tire tread without over-abrasion
- The tire surface without crack or damage

•Engine oil

- Oil level is correct

•Coolant system

- The coolant level is correct
- The coolant is without leakage

•Lights system

- The headlight/front position light, taillight/brake light, turning signal light, registration plate light and instrument light could be normally on.

•Indicator light

- Control the dimmer indicator light, neutral indicator, and turning signal indicator by switch assembly which could normally work. Oil pressure alarm, EFI malfunction indicator, water temperature alarm light, oil level alarm light are without on or flashing after engine started.

•Horn

- Normally works

•Engine engine cut

- Normally works

•Side stand

- Release or pick-up normal
- Interlocking normal with ignition switch

•Back-view mirror

- Sit on the motorcycle and keep the motorcycle upright, clearly view the object 10m behind the motorcycle with width of 4m from the back-view mirrors.
- In case failed, adjust the angle of back-view mirror.

The engine starting

The side stand is laid down.

Check if the engine cut of engine is located at position "🔒".

Insert the key into the ignition switch and turn to position "🔑".

Confirm the engine is on the neutral gear, the neutral indicator light "N" on instrument may be on.

When the conditions above equipped, firmly grasp the clutch by left hand for ensuring the safety, press down the electrical starting button "🔌" by right hand without turning throttle lever.

After the engine started, keep the engine idling till completely pre-heated.

This model is with the interlocking design between ignition and starting circuit, and the engine could be only started under conditions below:

- The engine is at the neutral gear, both the ignition and engine cut at the position "🔑" on, and firmly grasp the clutch lever for safety.
- When gear is put in non-neutral gear "N", the ignition switch and shut-off switch are kept in switching on position.
- Pick up the side stand and firmly grasp the clutch lever.

Danger

The emission of motorcycle is with CO which is a gas without smell and color but poisonous.

Long idling in the place without sound ventilation is not allowed, for preventing poisoned.

Warning

The colder the weather, the longer time for pre-heating is needed, sufficient pre-heating helps lubrication and decreases the engine abrasion. Idling for a long time is not allowed due to the poor heat radiation may lead to engine overheat and damage.

Under cold conditions, for quick starting, press the electrical starting button while suitably turn the throttle grip.

The lubricant in engine only works only when engine is running. Push the motorcycle for a long distance when the engine doesn't work is not allowed. After the engine started, check if the indicator lights on the instrument permanently on or flash, in case it is, stop the engine and make corresponding inspection.

Driving on the road

- Ride on the seat of motorcycle from the left side.
 - Pick up the side stand.
 - Adjust the motorcycle vertical to the ground, and upright the handle bar, keep the wheel face forwards.
 - Firmly grasp the clutch.
 - Slowly turn the throttle lever towards acceleration direction, meanwhile slightly release the clutch lever, the clutch meshes, and the motorcycle gradually started.
 - Wear helmet, gloves, riding boots, special protective suits, and pants is necessary before driving, all of which are also important to short journey.
 - The factors below are bad for fast driving and please pay attention to.
 - Improperly adjusted pre-loading. –Loosened clothes.
 - Overloading or imbalance loading may also be bad for your driving and operation.
 - Just little drunk or drugs are bad for your sense or reflects and not allowed at all.
- Driving after drunk or took drugs are strictly not allowed.

Caution

This model equipped the side stand/interlocking switch, in case the engine is in any gear but not neutral one, lay down the side stand, the engine goes off immediately.

Warning

High speed gear for engine starting is not allowed which may damage the engine. The motorcycle starting adopts the 1st gear is a must.

Danger

Make sure pick up the side stand to its upper limit position before starting, or it may lead to turnover when turning left.

Use the gearshift device

- The gearshift device makes the engine steadily work within normal rotation speed.
- The gearshift ratio designed to adapt the engine characteristic, and the driver chooses the most suitable gear position according to running conditions, driving in high speed but at low gear position is not allowed.
- For making sure the smooth gearshift and impact on rear wheel, coordinate with using clutch, before shifting to high gear position, accelerate or decrease engine rotation speed.

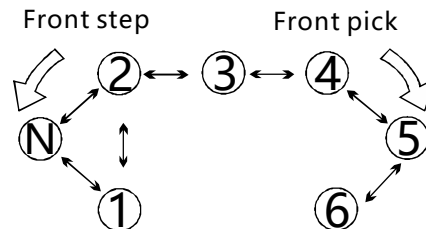

▲ Warning

Control the speed by the semi-clutch way is not allowed at any time. Sliding by grasping the clutch at any gear position is not allowed.

Brake and parking

- Decrease the speed by fuel returning before braking, meanwhile using the front and rear brake.
- When the speed is low enough, engage in low gear, brake to complete parking.
- Get into neutral gear and then the motorcycle completely stopped.
- When the front brake is braking, because your body moves forwards and the front shock absorber presses down, the more weight may suddenly move to the front wheel, in this case, the front wheel braking is more reliable, under this case, the front brake is more efficient than the rear one with easier parking.

- When you driving on the road in mountain, use rear brake only is a hidden risk. Under the limit conditions, the brake device may seriously overheat and damage. Reasonably use the deceleration function of engine, front and rear brake.
- When driving in rainy weather or water gathered road, the water on brake pads and plate may decrease the braking performance, and we suggest use when it dried up.

⚠ Danger

When decelerating in high speed, use the front or rear brake only may lead to the motorcycle skidding and out of control, so evenly use the front and rear brake is necessary.

⚠ Warning

- After long time driving and when parking is necessary, please park the motorcycle far from kids due to its hot engine for avoiding scald.
- Parking on soft ground is not allowed for avoiding the turnover and damage.
In case parking on the gentle slope, engage the engine in gear, then let the motorcycle head face towards uphill direction for avoiding side stand turning and overturning.
- Parking or driving on combustibles such as cured hay is not allowed due to the three-way catalyst working under high temperature which easy to ignite and lead to danger.

ABS unit

Alarm light

When opened the ignition switch, the ABS alarm light on instrument panel goes on for self-inspection, and then goes off when the driving speed reached 10km/h. In case the ABS alarm light is permanently on when the driving speed over 10km/h, which indicates there is malfunction in the ABS system and whose function failed, but under this case, the basic brake system still works, which means it equal to a motorcycle only without ABS unit, then contact the VOGÉ authorized distributor as soon as possible when the speed is still under control, send the motorcycle to the distributor by trailer if possible.

Danger

Normally, the alarm light is permanently on means malfunction, under this case, cut off the power source first and then connect. In case the alarm light goes off when the driving speed over 10km/h means everything normal; In case still on, which means there is malfunction and the repair is suggested.

We don't suggest close the ABS system when there is no emergency or special situation due to it may bring you hidden risk.

The use of ABS system

Brake the motorcycle the same with the one without ABS system, and powerfully press the front brake lever and rear brake pedal to their limit position, and the wheels would be without locking up and side skidding at this moment.

Use the point brake for front and rear one are not allowed when the motorcycle equipped the ABS system. When the ABS works, the front brake lever and rear brake pedal may slightly vibrate and rebound, which means the ABS begin the work and it is normal.

Caution

When driving on the bumping road without pavement, the intervention of ABS may be more frequent which could be strongly felt by hand and foot, and the braking distance may be longer than that on smooth road.

The initial use of the ABS system could be done on the safe area for practice, feel the intervention of ABS and the braking distance after that, which makes you play all the potential ability of ABS system when the emergency is met.

When under some extreme conditions such as the stunt show the wheels had large speed difference, for example the front or rear wheel raise or rear wheel skidding, the alarm light of ABS may be on and the ABS failed, but after stopped the motorcycle, turn off and on the ignition switch again, the ABS recovers its function.

Refit the motorcycle according to personal preference such as the travel of shock absorbers, the hardness of shock absorbers, the size for front and rear wheel rims and tires, the tire tread, the specification of brake pads and tire pressure, all of which may lead to the ABS fail to play its full performance, in case the parts above need replacement, contact the VOGÉ authorized distributor.

Warning

Install electrical parts with high power according to personal preference is not allowed, which may lead to ABS insufficient power supply and abnormal working, also may produce electromagnetic interference and lead to poor wheel signal and bad ABS work.

The speed sensor head on the front and rear wheel are with magnetism, check the cleanliness for gear rim and surface of speed sensor periodically, and also the gap between gear rim and detector of speed sensor, and the flatness of gear rim, all of which ensures the normal wheel signal especially after ran on the road with bad condition.

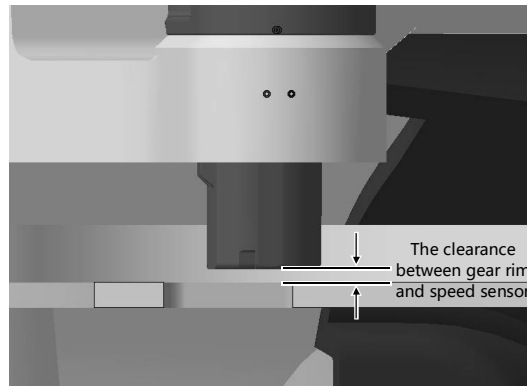
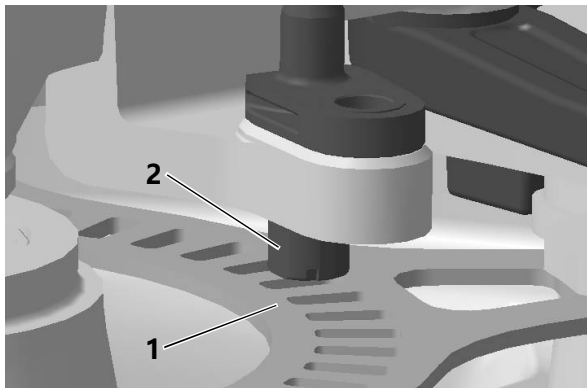

The gap between gear rim 1 and speed sensor 2:0.2mm~1.2mm

TCS traction control system

Confirm the skidding differential according to speed differential, then compare the speed between the front and rear wheel, finally fix the stability margin of rear wheel. In case more than the stability margin, the control system may adjust the engine torque.

Caution

The operations of TCS under some special road conditions:

In case the front wheel gets off the ground under very high speed, the TCS may decrease the engine torque until the front wheel touched ground once again. Under this case, we suggest slightly return the throttle grip to get into stable driving once again as soon as possible.

Sudden acceleration under full throttle on smooth ground is not allowed, because the engine torque may lead to rear wheel skidding and make it unstable, which could not be controlled by TCS.

On the very soft ground such as sand or snow, the TCS can largely decrease the driving power of rear wheel even makes it stop, under this case, we suggest stop the TCS at the moment.

Except the road conditions above, for the safe driving, please always open the TCS.

The ON/OFF shift of TCS please refer to P13 and P29.

The fuel

- The fuel consumption you saw when you purchasing the motorcycle is the one by the least consumption way under some even speed, which is largely different with your actual driving, in this case, you may find your actual fuel consumption is higher than the theoretic one.
 - The operation below may decrease your fuel consumption when you correctly driving the motorcycle:
 - The driving shall be soft, steady and reduce the frequency of sudden brake, the re-start and acceleration may increase the fuel consumption.
 - Driving in downtown area is bad for fuel saving, the frequent stop and start means the frequent engine starting.
 - The motorcycle shall usually drive under economic speed which is 90km/h, when you accelerate from 100km/h to 140km/h, the fuel consumption raised by 20%.
 - Drive motorcycle for a short journey shall be avoided. The fuel consumption of the first kilometer after motorcycle started is twice of the normal situation due to the engine hasn't played its full performance.
 - The insufficient air pressure in the tire may increase its rolling resistance which lead to incase of fuel consumption.
 - Periodic checking and maintenance are also the important way for saving the fuel.
- Except the reasons above, your driving technology may grow up with your accumulated mileage, for the driving fun, you may usually make sudden acceleration or deceleration, under this case, the fuel consumption may be more than soft and steady driving before, actually this is caused by your change of driving style.

The fuel evaporation

In case there is malfunction in fuel evaporation system, please contact VOGE service station for repair. Refit the fuel evaporation system is not allowed or it may break the fuel emission laws or regulations. After broke down and repaired, each pipeline shall be well connected without gas leakage or block; The rubber hose shall be without squeezing, crack or damage. The fuel vapor in the fuel tank releases to carbon canister through desorption tube, and when the engine stopped, the fuel vapor absorbed by the activated carbon in canister; And when the engine is working, the fuel vapor in canister releases to engine combustion chamber through the desorption tube to combust for preventing the direct emission of fuel vapor into air which lead to pollution.

The desorption is with the function for balancing the air pressure in fuel tank, when the air pressure in fuel tank lower than outside, supplement the air pressure through the air tube on canister and desorption tube; Under the cases, make sure the pipeline unobstructed, without squeezing or block, and make sure the correction installation of dumping valve, or the fuel pump may damage and the fuel tank may distort or crack and make other parts damage.

The fuel evaporation control system works as below:

- (1) When the fuel heated, then evaporated, and absorbed through the dumping valve to the canister TANK end;
- (2) When the motorcycle inclined over 60° , the dumping valve closed, the gasoline failed flow from dumping valve to canister.
- (3) The fresh air flows from the A end to PURGE end of canister which brings the fuel vapor into throttle valve, then flow from the air intake tube into engine join the combustion.

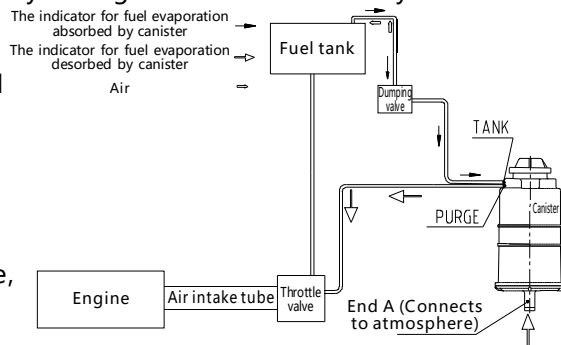

The diagram shows the connection for fuel evaporation control system

The Three-way catalyst

The emission system of this model equipped Three-way catalyst which decreased the harmful substance in the engine emission. The bad engine operation may damage the Three-way catalyst, so the actions below need be followed:

- Make the periodic maintenance according to <Guarantee and use manual>
- When the engine rotated unsteadily, contact the VOGÉ authorized distributor as soon as possible.
- When the fuel alarm light was on, fill up the fuel immediately, too low the fuel level may lead to unstable fuel supply.
- Start the engine by drawing or pushing the motorcycle is not allowed.
- Cut off the ignition switch when idling only.

Warning

The Three-way catalyst is a fragile component, for whom only unleaded gasoline could be adopted, the gasoline with lead may damage the Three-way catalyst and other important components.

Danger

Parking or driving on combustibles such as dried grass is not allowed due to the three-way catalyst works under high temperature which easy to inflame.

Troubleshooting

The content of troubleshooting is able to help you find out the ordinary malfunction, which are basic judge, in case they doesn't work, please send your motorcycle to the VOGÉ authorized distributor.

The engine starting failed

- Neutral gear, the ignition switch is on.
- In gear, the ignition switch is on, grasp the clutch lever and the side stand is picked up.
- If the fuel is enough.
- If the battery power is enough.

The hard engine starting

- If it is in the cold temperature, in case it is, slightly turn the throttle grip when starting.
- If the battery power is insufficient.
- To thick the oil, confirm if the oil need be replaced.

Weak power of engine

- If the air filter element is clean. If the fuel filter is blocked.
- If the motorcycle in the place of high altitude.
- The incorrect inspection and adjustment may damage your motorcycle and make the malfunctions fail to be found, of which these damages are out of Quality Guarantee policy. In case you are not sure about your operation, contact the authorized distributor.

Check and maintenance

Tools for motorcycles

The tool kit on board is put in the bottom plate of rear seat, insert into corresponding grooves in bottom plate of rear seat to fix its position.

After used after bad conditions such as rainy days or washing, the lubrication is necessary.

For driving safety, the fine lubrication for working parts is a necessary operation for prolonging their service life:

- Clutch lever shaft.
- Brake lever shaft.
- Brake pedal bearing.
- Side stand shaft and its spring hook.
- Main stand shaft and its spring hook.
- Main and pillion step and their returning spring.
- Transmission chain.

Battery maintenance

The battery for this model is the one with rubber body free of maintenance and inspect the electrolyte within service life is unnecessary, but periodic inspection for power charging is needed.

Caution

Except the chain needs its special lubricant, other lubrication points we suggest the lithium lubricant.

Caution

In case it is possible, charge the battery for 30 minutes before the first driving which could be effectively prolong the working life of batter.

The power charging of battery

In case the voltage of battery terminal is lower than 12.6V, we suggest the power charging.

- Charge the battery by DC voltage stability power source.
- The charging voltage DC(14.5±0.3)V; The charging current is lower than 1.2A.
- The charging time is about 6-8 hours without higher than the maximum charging current.
- The overcharging may shorten the battery working life, so it is not allowed.
- Disconnect the circuit of motorcycle with battery before charging.
- Usually check the cleanliness of battery terminals and wire joint, in case they are corroded or oxidized, clean them up immediately.
- In case the motorcycle is without driving for a long time, disconnect the negative terminal of the battery.
- When the motorcycle without driving over a month, charge the battery per month. In case the battery without charging for a long time, which easily leads to natural failure.
- Charge the battery by the suitable power charger and strictly follow its user manual.
- After the battery is well charged, disconnect from its charger immediately.
- The charging time for battery is relatively long.
- Keep and dispose the replaced batter and electrolyte in environment friendly way.

Danger

The battery may produce the combustible hydrogen, so keep far from heat source or spark. Wipe the battery by dry cloth may produce the electrostatic spark, so use the wet one for avoiding this situation.

Assembly and disassembly of the battery

- Before the disassembly and assembly of the battery, turn off the key of ignition switch first.
- Remove the negative terminal of battery first, then the positive one when disassembling.
- Install the positive terminal of battery first and then the negative one when assembling.
- After the battery well assembled, turn on the ignition switch for waiting 1 minute before starting engine to let the electrical equipment initialize.
- Long time parking without disconnecting the battery may lead to the electrical parts exhaust the battery, which makes the insufficient power when need be used.
- In case parking over one month, disconnect the guiding wire of battery or charging the battery before using.

The use of external power

- When the insufficient battery power failed start the engine, the external power could be used.
 - When starting the motorcycle by external power, adopt the special spring wire clip with both ends completely insulated for avoiding the guiding wires touch each other produce shortcut or spark.
- Batter A is a power supply on motorcycle while the battery B is an external one.

The positive terminal 1 of external power B connects the terminal 2 of motorcycle power supply A, and the negative terminal 3 of external power connects the metallic body of motorcycle for touching the ground. Start the engine, if failed, wait for minutes for next starting to protect the engine and battery. Let the engine work for minutes before removing the guiding wire of external power, then disconnect the negative wire and ground one, finally the positive guiding wire.

Warning

Place the battery upside down is not allowed, or the electrolyte may flow out from the breathing hole.

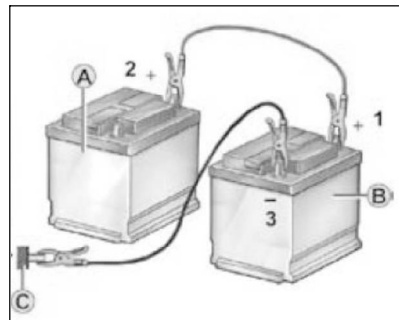

The maintenance of air filter

- The air filter located under the fuel tank. In case the air filter blocked by dust, it may lead to resistance for air inletting, power goes down and high fuel consumption.
- In case driving in dusty condition, increase the frequency of clean and replacement of air filter element.
- Clean and replacement of air filter element:
 - Remove the seat.
 - Remove the battery.
 - Remove the 4 pieces of screw on the cover of filter case and draw out as a whole.
 - Remove the 4 pieces of bolt connecting the element and remove it.
 - Clean up the element of air filter by compression air carefully.
- The broken air filter or its element may let dust enter the engine and damage the engine, in case it broken, please replace.
- The incorrect installation position of element may let the dust enter engine by bypassing and damage the engine. Please confirm its correct installation position.

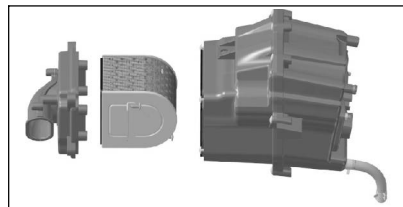

Caution

When cleaning the element, blow it from the side with metallic screen. In case blow from another side, the dust may remain and decrease the effect of cleaning.

Maintenance of oil in engine

The oil makes sure the effective lubrication of parts in engine, besides, it helps decrease the engine temperature which play the cooling performance, then, the oil also helps the engine sealing, in this case, the oil maintenance is very important for engine.

Check the oil level

- The oil level checking and oil filling up are both at the right crankcase of engine as figure 1 shown.
- The method for checking oil level:
 - Stop the engine when it was hot.
 - Make sure the motorcycle is upright.
 - Check the oil level through the oil view window.
 - The correct oil level shall be within the UPPER and LOWER scale mark of oil view window.
 - In case the oil level is higher than the upper scale mark, discharge some oil.
 - In case the oil level is lower than the lower scale mark, fill up some oil.
 - It is doesn't matter discharge or filling-up, after finished, check the oil level again according to steps and methods above.

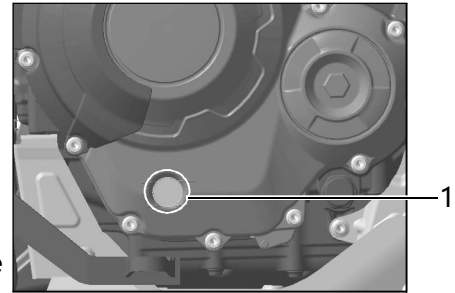

·The method for draining off the oil

–In case the oil level is too high, remove the oil drainage bolt by socket wrench, the position of oil drainage bolt is shown as figure 1 below, which at the lower left of engine.

–After suitable amount of oil outflow, screw up the oil drainage bolt.

Too low or high the oil level may both damage the engine.

Please make sure the oil level at the correct position.

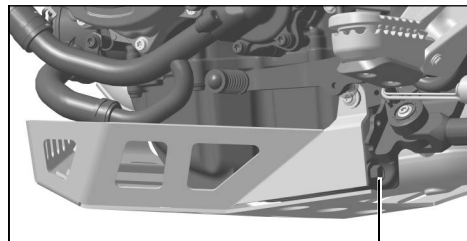

⚠ Caution

The oil may expand with the temperature rise, so the oil level changes with the temperature. The oil in hot engine may be higher and lower under cold status, which are both normal. When checking the oil level make sure the motorcycle upright, which is so called vertical to the ground.

Replace the oil in engine

- When the motorcycle reached the maintenance period, replace the oil in engine.
- Replace the oil when the engine is hot to completely drain the oil off.
- The method for oil replacement:
 - Make the motorcycle upright by parking stand.
 - Screw off the cap of oil filling-up port anticlockwise and remove.
 - Lay an oil dish under the oil drainage bolt, then remove the bolt by tools, then drain off the oil. Screw up the oil drainage bolt before filling-up new oil.

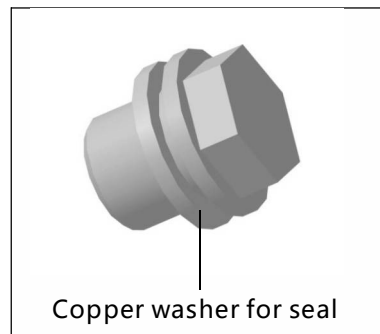

Warning

When re-assembled the oil drainage bolt, replace for a new one and its sealing copper washer, in case adopted the original one, it may lead to oil leakage.

Danger

The complete draining off can be done when the engine is hot, but the hot oil and muffler may make you hurt, so drain the oil off before the bolt and muffler completely cooled down.

Replace the oil element

- When the maintenance period reached, replace the engine oil element.
- Replace the oil element when the oil in engine was drained off.
- Lay an oil absorbing paper or a cotton cloth under the oil element cover for preventing the oil touches the engine surface when removing the cover.
- Remove the oil element at the front of engine.
- Remove the oil element and drain off the oil.
- Replace for a new oil element.
- Re-assemble the oil element, correct location of o-ring on oil element cover when re-assembling is important, or the oil may leak.

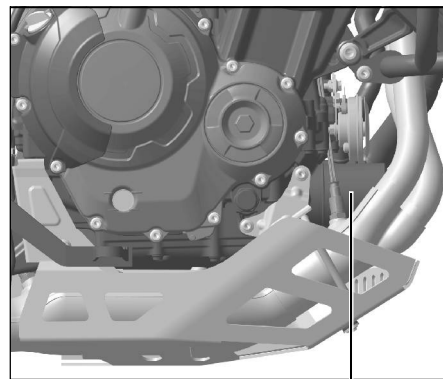

Oil element

Warning

Check and confirm the o-ring on oil element cover is fine, in case not, replace for a new one. Replace for a wrong oil element may damage the engine, so adopt VOGÉ original parts is necessary.

Fill up the engine oil

- Confirm the oil element was replaced and its cover was also assembled.
- The oil drainage bolt and its gasket were replaced and assembled.
- The first time fill up the fresh “Engine oil of VOGÉ motorcycle” from the filling-up port of engine, then screw up the oil port cap” , and make the engine run under different speed for 5 minutes, meanwhile check the leakage of disassembled parts.
- Finally, check the oil level.

Caution

Oil specification: 10W/40-SL and above,
filling-up volume: 3.0L
Dispose the replaced oil and element in
environment friendly way.

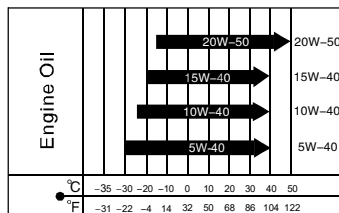

If you need to use them in winter, please exchange 5W-40 or 0W-40 low temperature resistant oil and you need to exchange 10W-40 or 20W-50 oil again in Summer.

Warning

Oil of wrong specification or with poor quality may damage the engine and EFI parts, also may shorten the working life of spark plug and catalyst in muffler, whose adoption is not allowed.

Check and maintain the coolant

The coolant brings away the heat of engine parts which keeps the normal engine working temperature.

- Check the coolant level and filling up are done at the expansion tank.
- Stop the engine.
- Because the coolant may expand with the temperature, so check its level when the engine was cooled down.
- Make sure the motorcycle is upright.
- Observe the level in expansion tank which make sure it is within scale marks LOWER and UPPER.
- In case the coolant level is under LOWER, fill up from the port of expansion tank.
- In case too high the coolant level, the coolant may expand with temperature rise which may inject out from the overflow tube, in this case, overfilling is not allowed.
- Frequent coolant filling-up indicates the malfunction, under this case, contact the VOGÉ authorized distributor.

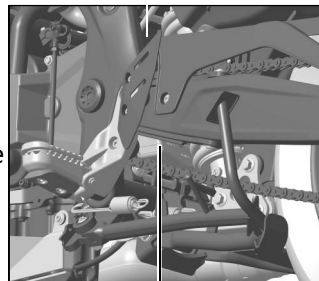

Water tank

Warning

In case the expansion tank was completely dried, fill up the coolant is not allowed, under this case, the air already entered the coolant system need be exhausted first which only could be done by VOGÉ authorized distributor.

Replace the coolant

·Drain off the coolant:

- Keep the motorcycle upright by parking stand.
- Lay a liquid dish under the engine.
- Remove the water drainage bolt. Because the heat radiation system is connected, so all the coolant may flow out from that drainage port.
- Re-assemble the drainage bolt when the coolant was completely drained off.

·Fill up the coolant:

- The coolant need be filled up from heat radiator and expansion tank:
- Open the water tank cover of heat radiator as figure 2 shown, then fill up the coolant.
- Observe from the tank cover of heat radiator to confirm the coolant is full, filling-up while squeezing the water tube for exhausting the air till it full, then screw up the cover.
- After screwed up the tank cover, start engine for 30 seconds to make sure the coolant spread to each part need it.
- Stop the engine, and open the water tank cover again when the engine was cooled down to check if the coolant is really full, in case the level fell down, fill up again till full again, repeat this action till it fulfilled, this action need be repeated if necessary.
- Finally remove the black rubber cap 3 on expansion tank till the coolant level reached position between scale marks UPPER and LOWER.

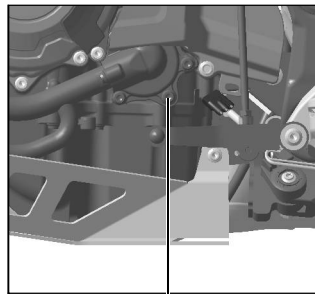

Water drainage bolt

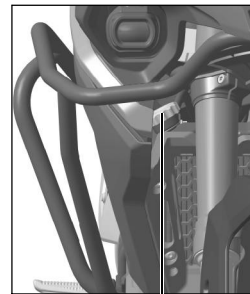

Water filling-up port

⚠ Warning

Fill up by running water is not allowed, or it may damage the cooling system.

Mixture of coolant from different specification is not allowed due to various ingredient.

- The coolant with higher performance shall be adopted in case colder than the temperature marked on the lable.
- The coolant passed the VOGE test is with ice point of -45°C of ethylene glycol. In case replacement or purchasing is needed, please contact the VOGE authorized distributor.

 **Caution**

For ensuring the coolant performance, replace the coolant each two years.
The coolant specification: The coolant with ice point of -45°C of ethylene glycol.
The filling-up volume: 2.0L.
Dispose the replace coolant in environment friendly way.

 **Danger**

During the filling-up, let the engine cool down when re-opening the tank cover of heat radiator after the engine worked, or the hot liquid may inject out when you opening the cover and make your scald.

Maintain the brake fluid

The brake fluid is an important medium for transmitting brake power in hydraulic brake system, which needs reliable performance in high and low temperature especially nice flowability in low temperature, meanwhile need be anticorrosive, so choose the correct brake fluid.

Check the brake fluid

- Too low the brake fluid level in the oil cup may lead to air enter the brake system, which evidently decrease the braking performance, so the periodic checking is necessary.
- Checking and filling-up are both be done at the oil cup of front and rear brake.
- The liquid level shall not be higher than mark (UPPER or MAX),when it lower than mark (LOWER or MIN), please fill up immediately.
- The brake fluid is corrosive, in case touched the surface of paint or plastics, it may make corrosion.

Warning

When the filling-up, open the brake oil cup's cover may lead to air or water entry, which may sharply decrease the braking performance even failure, under this case, please contact the VOGE authorized distributor for supplement or replace.

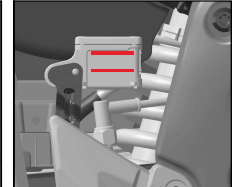
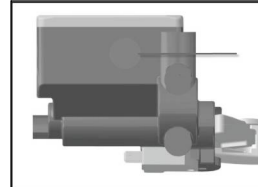

Brake fluid specification

- In case there is water or impurity in the brake liquid, it needs be replaced or filtered, or the braking pressure may be insufficient which decreases its performance, which is especially important in wet place or weather.
 - The brake fluid may go bad when used more than 2 years, in this case, prompt replacement is necessary.
- The brake fluid's specification: DOT4, please dispose the replaced brake fluid in environment friendly way.

Caution

Mixture of brake fluid from different brands of specifications are not allowed due to various ingredient may decrease the braking performance.

Maintain the transmission chain

The transmission chain on this model is the one with oil seal which at the pin of chain and with lubricant grease inside, and the chain is the type of locking ring without opening, so the replacement of chain needs special tools and only could be done by VOGÉ authorized distributor.

Check or adjust the chain before every driving, and confirm the problems below:

- Flexible pin of the chain
- The pin roller damage
- Rusty chain plate
- Chain link jammed
- In case problems above were found, contact the VOGÉ authorized distributor immediately.

The abrasion on the chain may also makes that on the sprocket wheel, please confirm the problems below:

- The over-worn sprocket wheel
- The teeth of sprocket wheel broken or cracked
- In case problems above were found, contact the VOGÉ authorized distributor immediately.

Clean up and lubricate the chain

The dirt or dust on the chain may shorten its working life, so the periodic clean and lubrication is necessary, because there is o-ring and lubricant at the position of chain's pin, which may be damaged due to incorrect washing and lubricating, and also may decrease the chain's working life.

- Wash the chain by wire brush is not allowed.
- Wipe up the chain immediately after washed, dry it up for lubricating.
- Adopt the oil for oil-sealed chain only and evenly spread on inner and outer chain plate. After spread, wipe up the surplus oil.

Some kinds of chain lubricant include the resolvent or additive agent may damage the o-ring, so the lubricant for oil-sealed chain only is necessary.

Caution

Check the abrasion situation of driving and driven sprocket wheel when replacing the transmission chain, replace the sprocket wheel together if necessary.

In case there is no oil for oil-sealed chain only, adopt gear oil of SAE90 with high thickness for substitution.

Warning

- Wash the chain by water or neutral cleanser.
- Wash the chain by resolvent with volatility is not allowed such as paint thinner or gasoline.
- Wash the chain by cleaner with high pressure is not allowed.

Adjust the transmission chain

- Too tight or loose the chain are both incorrect.
- Too loose the chain may make it drop from sprocket wheel which lead to accident.
- Too tight the chain may decrease its working life while increasing the transmission resistance.

The correct tightness is shown as picture:

In case your chain fell short of meeting the requirement above, the adjustment is needed and shown as below:

- Make the motorcycle upright by parking stand.
- Turn and loosen the nut 1 on rear wheel axle and adjusting nut 2, then adjust the bolt according to the tightness.
- In case too loose the chain, turn the bolt anticlockwise.
- In case too tight, turn the bolt clockwise and powerfully push the rear wheel forward to get looser.
- When the tightness is suitable, adjust the bolt both sides for fine adjustment, and align the scale marks on adjusting piece and rear fork.

- Lock up the nut 1 on rear wheel axle and adjusting nut 2 both sides.

Specification for transmission chain:

Type: 520 Links: 114

Oil-sealed chain without opening

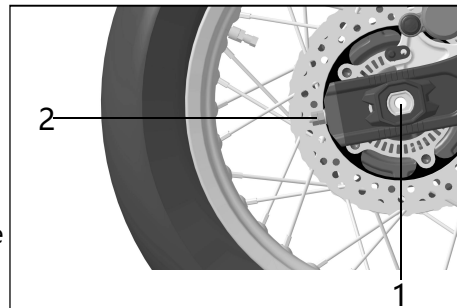
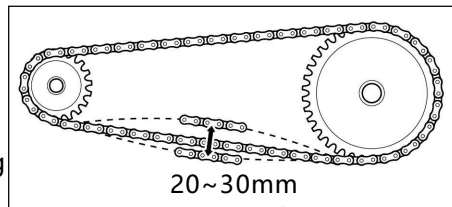

Fastening torque of adjusting nut: 22NM
Fastening torque of rear wheel axle: 95NM

⚠ Danger

This chain adopted clamping ring without opening, use the one with opened clamping ring is not allowed, or the chain may drop and lead to accident.

Replace this kind of chain needs special tool, the poor riveting of clamping ring without opening may also drop and lead to accident.

Maintain the tire

The tire connects the motorcycle and ground which is very important. Incorrect tire specification or size may largely influence the motorcycle performance.

Pressure in tire

- The incorrect tire pressure may decrease the working life of tire.
- The low air pressure in tire may lead to difficult turning and increase abrasion.
- The high air pressure in tire may decrease the contacting area to ground, which is easy to skid and bring the motorcycle out of control.
- When driving in high speed, the valve core tends to be open under the centrifugal force on the tire. For preventing the sudden air leakage, there is a rubber cover with metallic liner which assembled on the valve core by threaded way.
- The air charging pressure and the tire temperature are the direct proportion. In this case, adjustment for tire charging pressure under cold status could be done only when the tire temperature was basically same with that in environment.

Check the abrasion limit of tire

- There is an abrasion mark on tire surface.
- The tire tread reached the abrasion mark means the tire is unusable.
- The abrasion mark is near the TWI mark at the tire edge, which locates at the drainage channel of tire crown, whose shape like a protrusion, and when it broken, which means the abrasion reached the mark, then replace the tire immediately.
- Over-worn tire may make tire penetrate and bring motorcycle out of control.
- When the tire tread worn to the minimum allowed depth, its performance and gripping force may largely decrease.

Danger

The abnormal tire pressure may influence tire performance even lead to accident. Overloading may lead to tire malfunction which brings motorcycle out of control. Check tire pressure at least once per month.

Under normal temperature, check the tire pressure as the table shown below:

	Driver	Driver & Passenger
Front wheel	220KPa	250KPa
Rear wheel	220KPa	250KPa

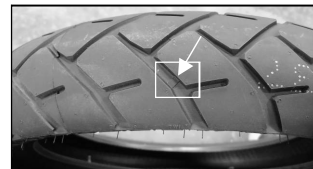

Repair the tire

- When repairing the tubeless tire with tiny hole, remove the tire and put a patch inside, outside is not allowed, because the high-speed running may make the repaired position loosen under centrifugal force.
- The driving speed over 80km/h is not allowed in the first 24 hours after repaired.
- In case the side wall of tire is broken or the broken size more than 6mm, the tire is unusable.
- Check the tire, in case many places are broken such as damages, scratches, or wear to the limit, the tire must be replaced immediately.

Replace the tire

- Tires on one motorcycle with different brands, specifications, tire treads, and new or old when replacing is not allowed.
- After the tire replaced, the wheel needs make the dynamic balancing test, whose poor dynamic balance may decrease the operation performance of motorcycle, also lead to the uneven abrasion of tire.
- The arrow on the tire indicates the rolling direction, which turn the wheel along it. This prevents the skidding on wet road surface, raises the adhering ability, decreases noise and prolongs the wear resistance, all of which optimized the tire performance.
- The appointed tires were passed strict test and verification which meet the demands of most road conditions. As for the tires haven't tested, whose suitability and safety could not be ensured.
- The contacting position between tubeless tire's lip and wheel rim need be sealed.
- For avoiding air leakage, the disassembly and assembly of tubeless tire need special tools and machine.
- The replacement of tire could be done only by VOGE authorized distributors who equipped necessary tools and experience.

The fuse

- Before replacing the fuse chip, please know well about the malfunction and make troubleshooting.
- All the specification and usage for fuse chips are marked and introduced.
- Fuse chip for power supply of motorcycle (30A): Controls the power supply and charging circuit for EFI system, ABS system, electrical load for motorcycle other systems (Instrument set or lights). Spare fuse chip: 30A (1 piece-Green-In the fuse box)
- Fuse chip for power supply of ABS system's motor (25A): Controls the power supply for motor of ABS anti-lockup system.
- Fuse chip for power supply of solenoid valve on ABS system (15A): Controls the power supply for solenoid valve of ABS anti-lockup system.
- Fuse chip for power supply of signal system (15A): Controls power supply instrument set, lights, horn, flasher, kill switch of side stand and starting relay. Spare fuse chip 15A (1 piece-Red-In the fuse box)
- Fuse chip for power supply of EFI system (10A): Controls power supply for ECU of EFI system, oxygen sensor, diagnosis interface of ECU, solenoid valve for carbon canister, oil injector, ignition coil and systems for EFI. Spare fuse chip: 10A (1 piece-Blue-In the fuse box).
- Fuse chip for power supply of electric fan: Controls power supply for electric fan. Spare fuse chip: 10A (2 pieces-Red-In the fuse box).

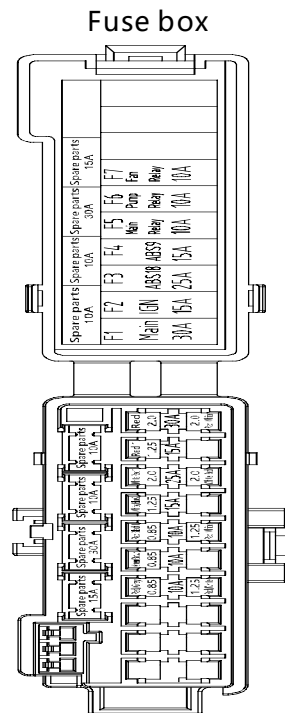

–use chip (10A) for fuel pump's power supply: Control power supply for fuel pump. Spare fuse chip: 10A (2 pieces-Red-In fuse box).

·When checked or replaced fuse chips, please well install the fuse box cover in place, otherwise in rainy days or after washed motorcycle, the water may get in which leads to bad electrical malfunctions.

⚠ Caution

In case the fuse usually blows within short time, which indicates the malfunction in electrical system, please contact the VOGÉ authorized distributor immediately.

⚠ Danger

- It is necessary to adopt the appointed fuse without substituting by iron wire or aluminum foil.
- Direct connection or adopt fuse out of appointed ones are not allowed, which are bad for motorcycle even catches fire.

Brake pads

When the abrasion passed the minimum limit may decrease the braking effect. Under some cases, it may damage the brake system. For the reliability of brake system, the pads abrasion over minimum limit is not allowed.

Replace the brake pads

The correct way for replacing the brake pads needs remove the wheels, so we suggest contact the VOGÉ authorized distributor for this work.

- Both the front and rear brake pads need be replaced as a set, in case replace only one piece, it may lead to imbalanced braking which makes accident. Operate the brake lever or pedal when the brake pads removed is not allowed, or it may make the difficult returning of brake piston, also the risk of brake fluid leakage.
- The oil or other dirt touches brake pads and plate when replacing is not allowed, in case it is, clean up is necessary, or it may make skidding brake and decrease the braking effect.

Abrasion limit position for front brake pads:

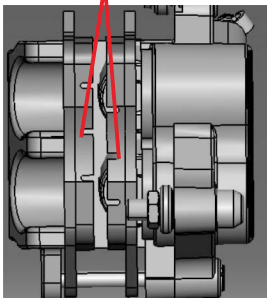

Limit abrasion position for rear brake pads:

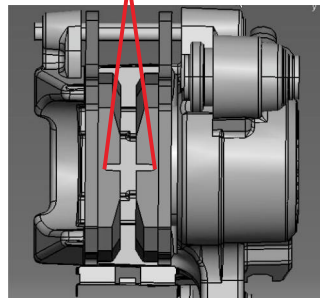

Danger

After the brake pads replaced, repeatedly confirm by brake lever and pedal for making sure the brake pads tightly pressed the brake plate. Meanwhile confirm the correct free travel of brake lever and pedal.

Replace the fuel filter

- The fuel filter is for filtering the impurity in fuel for preventing enter the fuel injector.
- The nozzle of fuel injector is extremely fine, which may be easily blocked, the blocked injector doesn't work makes engine starting failure.

Replace the fuel filter on time is necessary.

- Remove the fuel tank, which could be seen from the bottom of fuel tank.
- Remove the clamp of fuel filter by screwdriver.
- Wrap up the both ends of fuel filter by cotton cloth for preventing the fuel splash when removing the clamp due to the residual fuel and pressure in the fuel tube, whose residual fuel may splash with the pressure.
- Remove the clamp on both sides of fuel filter by screwdriver.
- Replace for new fuel filter (Pay attention to its directions of fuel intake and outflow).
- Re-assembly is completely opposite to assembly.
- Absorb the splashing residual fuel in fuel tube by cotton cloth when removing the filter.

⚠ Caution

Replace the fuel filter each 5000km.

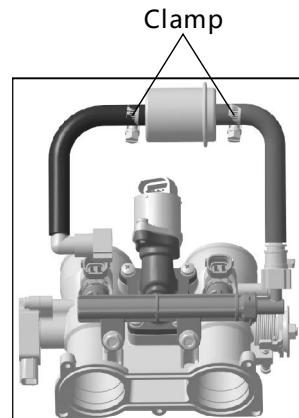

Dispose the replaced fuel filter in environment friendly way.

Replace the lighting signals

- You may fall in danger without signal light due to it makes you and your motorcycle be easily found. Promptly replace the broken signal light.
- Headlight, position lights, turning signal lights, rear position light/brake lights and registration plate light are all the LED sealed light, in case broken, the replacement could be done only by service station.

The shifting of signal light please follow the specification in table below.

The dirt especially the grease may disturb the outward heat radiation of signal light which may lead to overheat and shorten their working life.

Warning

When a signal light broken, replace for a new one with same rated power and specification, or may lead to circuit overloading or shorten the working life of the bulb.

The storage and cleaning up of motorcycle

The storage

- In case parking for a period is needed, the special maintenance is necessary, which needs some special materials, equipment and technologies, so we suggest do this work by VOGÉ authorized distributor due to the causes above.
 - If you want to do this work by yourself, follow the method below:
 - Replace for fresh oil.
 - Block the air intake port of air filter and exhaust port of muffler by cloth with fresh oil for preventing the wet air get into engine.
 - Dain off the fuel in its tank.
 - Remove the battery, and wash its surface by neutral soapy water, meanwhile clean up the oxidizing material on positive and negative terminals.
 - Store the battery in a room with temperature above 0 °C.
 - Adjust the tire to suitable air pressure.
 - Completely wash the motorcycle.
 - Spray the protective agent to rubber parts.
 - Coat the appearance parts with automobile protection wax.
 - Finally cover the motorcycle by dry cloth shield and store at the dry place with fine ventilation..
- Use again the motorcycle
- Totally clean up the motorcycle.
 - Remove the cloth blocked the air intake port of air filter and exhaust port of muffler.
 - Totally replace the oil in engine and the oil element. ·Install the battery. ·Start the motorcycle.

 Caution
Charge the battery once per month.

The motorcycle protection

- Usually wash the motorcycle according to using situation, keep the motorcycle clean and dry if possible.
- Wash up the dirt attached on motorcycle surface such as bird droppings, asphalt and salt.
- Use the motorcycle cloth shield if possible, parking under sunshine for a long time may lead to color fading and appearance parts aging.

Clean up the motorcycle

- Wash the motorcycle by cold water.
- Totally wash up the motorcycle by soft cloth with neutral cleanser.
- Wash the motorcycle by spray is not allowed.
- Wash the motorcycle by high pressure water is not allowed.
- After drove in rainy days or washed, there would be a few water mist in headlight or turning signal lights, turn on the lights for a while the mist may disappear, because the lights are all designed with air vent, which is normal.

Danger

The wet brake device may have low braking ability, repeatedly test the brake system under low speed after washed which make it quickly dry up.

Refit and accessories

Adopt original parts and accessories of OEM on your motorcycle is allowed.

- Get original parts and accessories or other related products from authorized distributor, meanwhile, the person with specialization may introduce their installation and usage.
- The safety, utility and compatibility are tested and qualified, we are responsible for them.
- Otherwise, the parts or accessories without authorization, we take no responsibility.
- Any parts plan to be replaced must abide by the laws. Make sure your motorcycle won't beak any laws, regulations and specifications.

Danger

Refit the parts related to performance like ECU without authorization may damage the motorcycle and lead to accident.

The motorcycle parameters

Motorcycle parameter	
LxWxH	2230mmx850mmx1395mm
Wheel base	1465mm
Seat height	835mm
Ground clearance	220mm
Curb weight	206kg
Loading capacity	183kg
Maximum weight	389kg
Front wheel loading	102kg
Rear wheel loading	104kg
Maximum design speed	High power: 183km/h
	Low power: 160km/h
Max. gradeability	≥40°
Braking deceleration	Execute the GB20073
Fuel consumption ration	≤4.8L/100km
Fuel tank capacity	17.6L
Coolant capacity	2.0L
Chain specification	520SX3114 links
Suspension/Brake system	
Front shock absorber type	Inverted shock absorber/ Tube Φ41mm Stroke 174mm
Rear shock absorber type	Central shock absorber/Stroke 69.5mm
Front wheel hub specification	2.50x19
Rear wheel hub specification	4.25x17
Front tire specification	110/80R19
Rear tire specification	150/70R17
Front brake type	Double plate, double piston, floating caliper/plate diameter 298mm
Rear brake type	Single plate, single piston, floating caliper/plate diameter 240mm
ABS	2-channel anti-locking up brake system

Engine system	
Engine type	Double cylinders in line/Water cooling/8 valves/DOHC
Bore x Stroke	76mmx64mm
Displacement	581ml
Compression ratio	11.5: 1
Inlet valve clearance	(0.10-0.15)mm
Exhaust valve clearance	(0.15-0.20)mm
Spark plug clearance	0.8mm-1.0mm
Spark plug type	CPR8EA-9
Maximum net power	47kW/9000r/min
	35kW/10000r/min
Maximum torque/rotation speed	57N.m/6500r/min
	47N.m/6500r/min
Idle speed	(1300±100)r/min
Gear box type	International 6 gears
Clutch type	Wet multiple layers
Engine oil capacity	3.0L(10W/40-SL)
Oil supply system	EFI system
Emission standard	EURO V+
Transmission system	
Primary transmission ratio	1.826
Final transmission ratio	2.867
1st gear	3.285
2st gear	2.105
3st gear	1.6
4st gear	1.3
5st gear	1.15
6st gear	1.043

Electrical system	
Battery specification	12V 10Ah
Headlight (High/Low beam)	12V 33.6W/19.2W
Front position light	12V 6.22W
Rear position light	12V 1.1W
Rear brake light	12V 2.19W
Front turning signal light	12V 1.1W
Rear turning signal light	12V 1.1W
Rear registration plate light	12V 0.257W
Chip fuse specification	30A、25A、15A、10A

- Pay attention to each periodic maintenance and confirm it strictly follow this user manual.
- The maintenance in its table stands for the least times only, in case your motorcycle usually run in extreme conditions, the maintenance shall be more frequent.
- In case there is sandy or muddy condition within your long journey, the special maintenance is necessary after your journey.
- This kind of maintenance we suggest shall be done by VOGÉ authorized distributor.
- The waste materials produced by maintenance such as cleanser, waste oil shall be disposed in environment friendly way without making pollution.
- The correct spare parts is the key for maintenance, in case you are not sure about the origin or the quality of the spare parts, we suggest you adopt the OEM parts, and incorrect maintenance may lead to accident in future.
- This kind of maintenance we suggest shall be done by VOGÉ authorized distributor.

The maintenance plan

The details for each periodic maintenance is shown as the Table below, the interval set the first arrival between driving time and mileage as standard. Each inspection and maintenance need follow the Table below.

Periodic maintenance table									
	Items	Interval	km×1000						
			1	7	13	19	25	31	37
Power transmission system	Lubricant		R	R	R	R	R	R	R
	Lubrication element		R	R	R	R	R	R	R
	Check lubricant level		I	I	I	I	I	I	I
	Check seal performance for fuel tube		I	I	I	I	I	I	I
	Check the fuel pump element		\	\	I	\	I	\	I
	Fuel filter		\	R	R	R	R	R	R
	Throttle valve body/Carburetor		\	\	\	C	\	\	C
	Check coolant level		I	I	I	I	I	I	I
	Coolant	2 years	\	\	\	\	\	\	R
	Check seal performance of air inlet system		I	I	I	I	I	I	I
	Valve clearance		\	\	\	I	\	\	I
	Spark plug clearance		\	I	I	R	I	I	R
	Air filter element		I	C	R	C	R	C	R
	Throttle operation system		A	A	A	A	A	A	R
	Clutch operation system		A	A	A	A	A	R	A
Lubrication system	Check lubrication and tightness for steering bearing		I	\	L	I	L	I	L
	Check lubrication for Fr. & Rr. Wheel and sprocket base bearing		\	L	L	L	L	L	L
	Check lubrication for tuning shaft of main and pillion steps		\	L	L	L	L	L	L
	Check lubrication for side stand shaft		\	L	L	L	L	L	L
	Check lubricant for brake and clutch lever shaft		\	L	L	L	L	L	L
	Check lubrication for bearing on rocker rack of rear shock absorber		\	L	L	L	L	L	L
	Check lubrication for bearing of rear fork shaft		\	L	L	L	L	L	L
	Check lubrication for driving chain		A	A	A	R	A	A	R
Others	Battery voltage		\	I	I	I	I	I	I
	Seal performance for brake oil tube		I	I	I	I	I	I	I
	Brake liquid	2 years	I	I	I	I	I	I	I
	Brake liquid level		I	I	I	I	I	I	I
	Fr.& Rr. Brake pads		I	I	I	R	I	I	R
	Fr.& Rr. Brake switch		I	I	I	I	I	I	I
	Check fuel evaporation system		I	I	I	I	I	I	I
	Check tightness of fastening pars on body		I	I	I	I	I	I	I
	Check leakage for Fr. & Rr. shock absorbers		I	I	I	I	I	I	I
Aluminium alloy wheel/Spoke wheel		I	I	I	I	I	I	I	

Meaning of symbols: I: I: Inspection, adjust if necessary C: Clean R: Replacement A: Adjustment L: Lubrication

The VOGE key parts fastening daily inspection*DS625X

Ref.No.	Fastening parts position	Thread	Numbers	Torque (N.m)
1	Front wheel axle	M18	1	75
2	Front wheel axle lock-up	M8	2	18
3	Front disc brake caliper and shock absorber	M8	4	32
4	Rear fork axle	M14	1	120
5	Engine and frame	M10	6	55
6	Rear suspensiton rack fastening(Rear shock absorber, bigger & smaller swinging rack, frame and rear fork)	M12	5	60
7	Rear wheel axle	M20	1	105
8	Nut of chain adjustor	M8	4	9 (The first one and adjustor) 22 (Between two nuts)
9	Front shock absorbers and steering stem	M8	6	18

Electrical schematic diagram

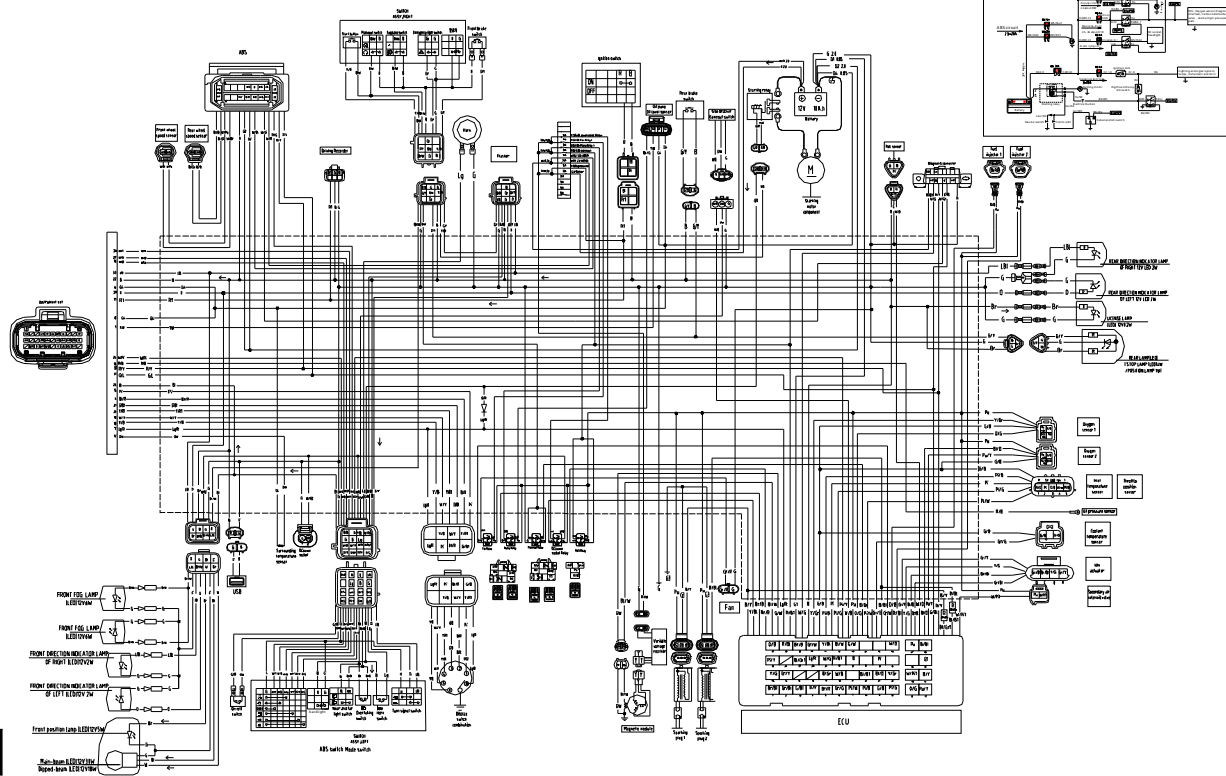



Maintenance download



Facebook

www.vogeglobal.com